

Temperature/Rh Data logger

Users Manual

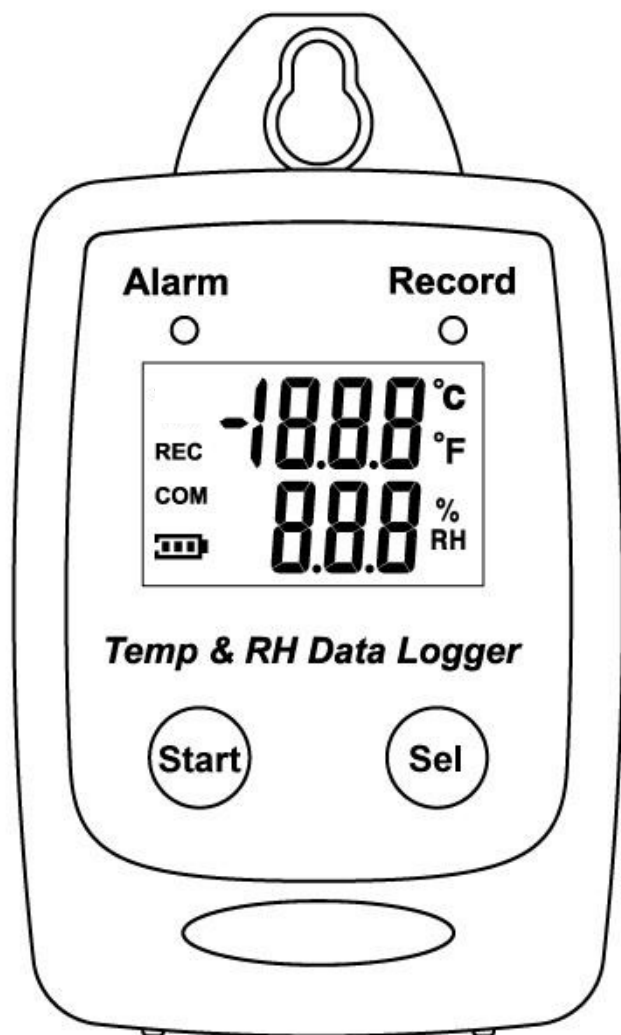

USB Datalogger
IP 54 Water Proof

TABLE OF CONTENTS

FEATURES & SPECIFICATIONS.....	3
START UP AND GENERAL OPERATION	7
LCD Display	8
Sampling Rate.....	9
Recording and Datalogging	10
PC SOFTWARE INSTALLATION	11
USING PC SOFTWARE	14
Connect Temperature/Rh Datalogger to PC.....	14
Setup Screen	17
Download Records	19
Graphic & Chart Analysis	22
Data in Listing Format	23
Data Export	25

FEATURES & SPECIFICATIONS

Features

- Measure humidity and temperature-
- Datalogging- 25,000 records
- Fast USB download
- Easy- to-Use PC software for parameter settings and data analysis
- Internal Humidity Temperature alarm

Specifications

General

Operation Condition	-40-185°F (-40-85°C)
	1-99% RH, non-condensing

Relative Humidity Sensor

Type	Capacitor
Measurement Range	1%-99%
Accuracy	±3.0%RH(20~80%) at 25°C ±5.0%RH(<20%,>80%) at 25°C
Resolution	0.1%

Temperature Sensor

Type	Thermistor
Measurement Range	-40-185°F (-40-85°C)
Accuracy	±0.6 °C (±1.2 °F) from -20-50 °C (-4 to 122°F) ±1.0°C (±1.8°F) all other ranges.
Resolution	0.1 °C

Power Supply

Battery	One 3.6V ½ AA lithium battery
Battery Operation	1 Year
External Power Supply	5 VDC with 0.5A. 

Applications

- Building HVAC monitoring
- Indoor air quality survey
- Locate the presence of combustion fumes from vehicles and appliances

LCD Display

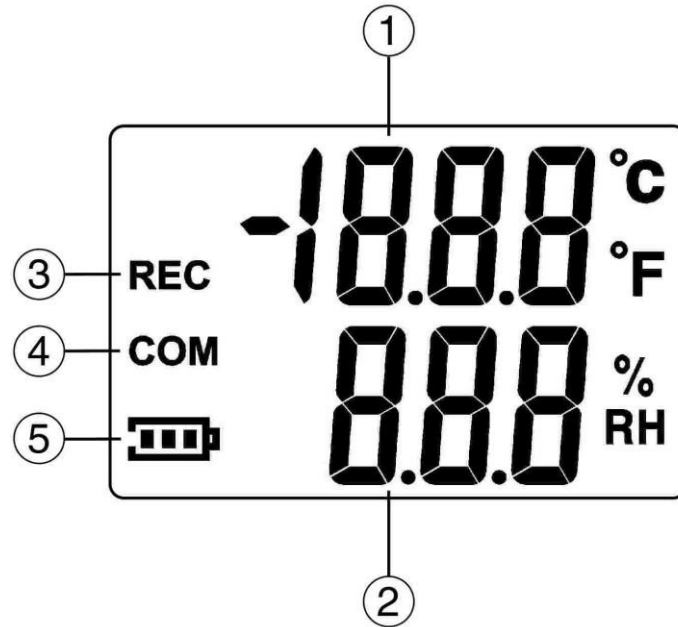

LCD

1.	Temperature Display	4.	USB Communication
2.	Humidity Display	5.	Battery Level Indicator
3.	Recording		

WHAT'S IN THE BOX

1. Main Unit

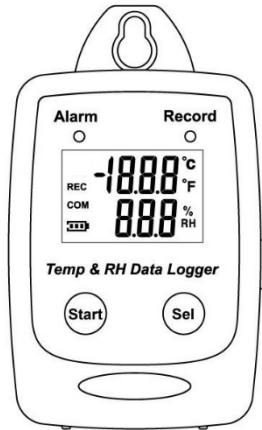

2. USB Cable



3. Installation Disk

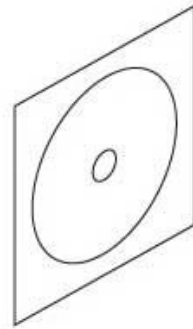

4. 3.6V ½ AA
lithium battery



START UP AND GENERAL OPERATION

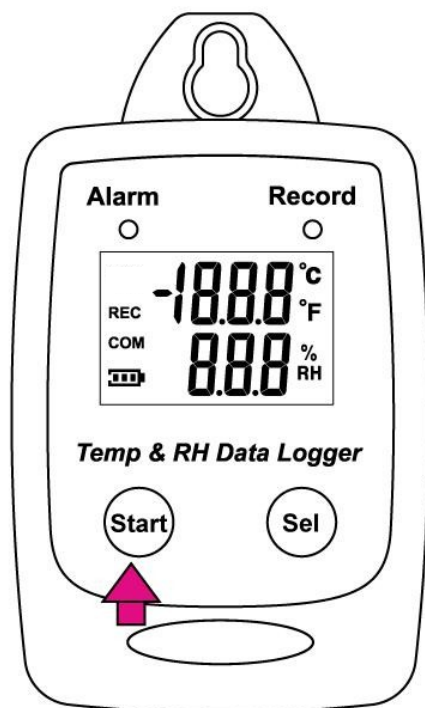

- Press the Start button for 2 seconds to turn on Temperature/Rh Datalogger
- The unit is ready to use.

LCD Display

- Press Sel to jump to the next LCD display.

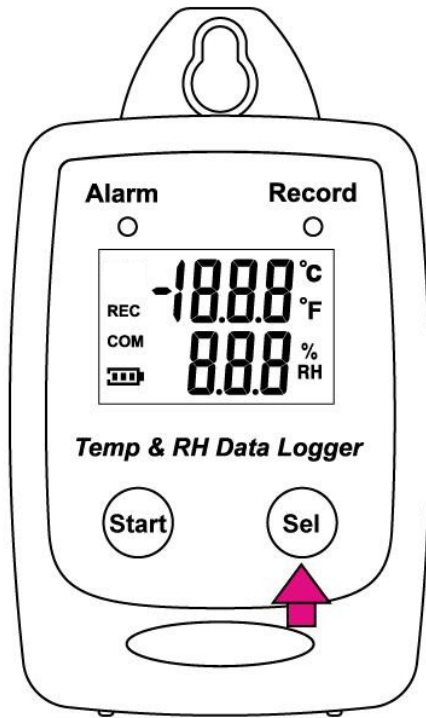

- Main Screens (1-3)

1.	2.	3.
Main Screen Temperature(C)	Main Screen Temperature.(F)	% of Memory Left Total 24,000 records

Main Screens

Sampling Rate

(5sec / 10sec / 30sec / 1min / 5min / 10min / 30min / 1 hour/ 2 hour)

Can only be set from PC setup screen.

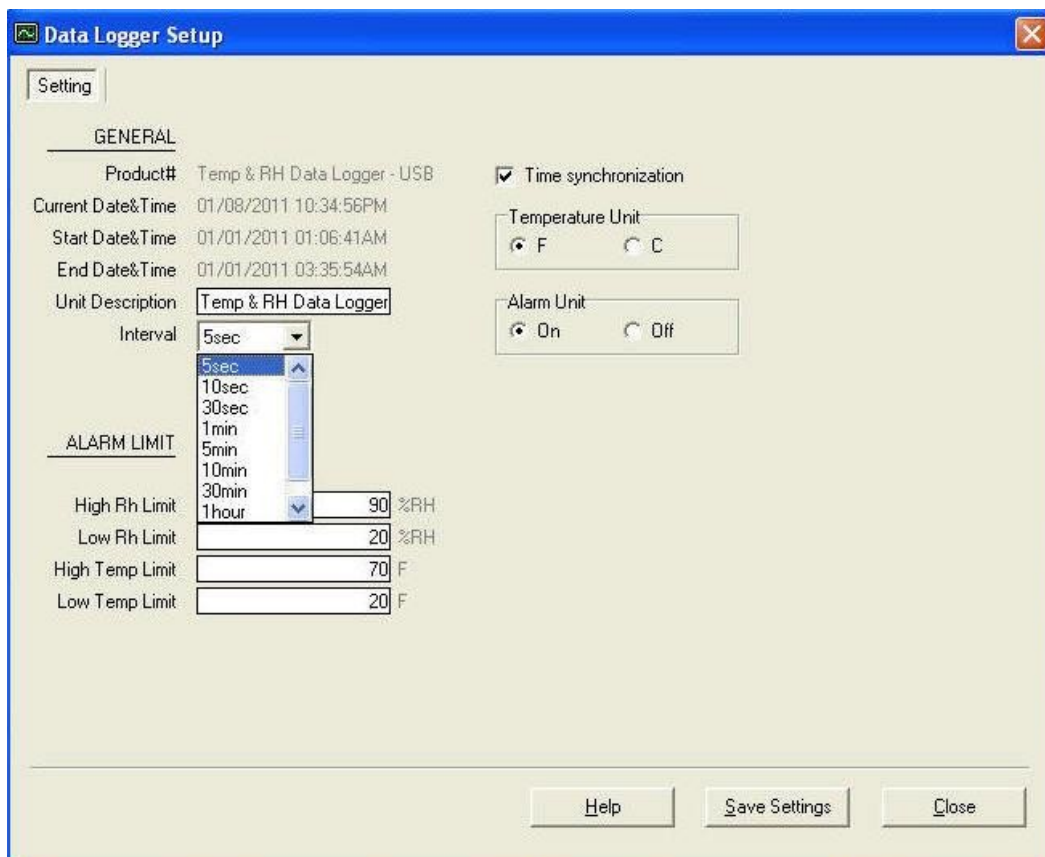

Recording and Datalogging

- Press the Start button to start data recording.

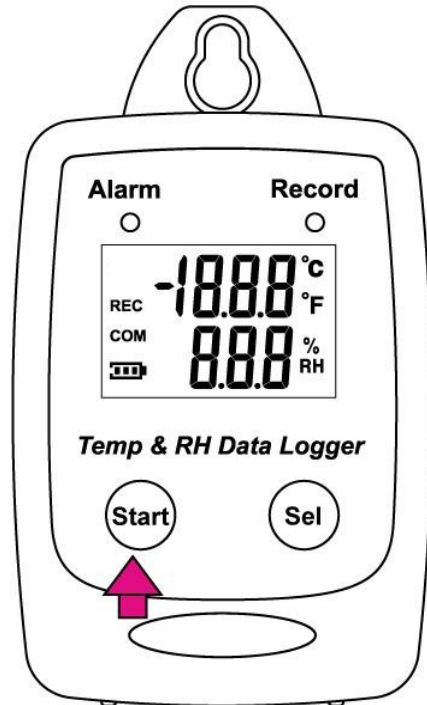

- The LCD will display REC when Temperature/Rh Datalogger is in the datalogging mode.

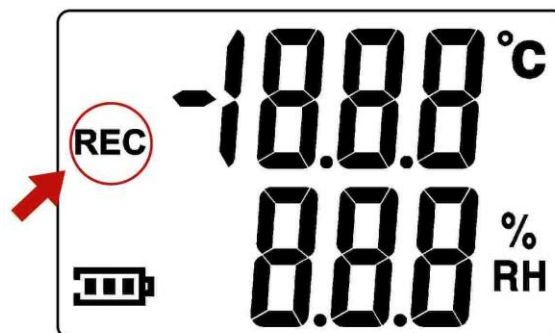

- Press the Start button again to stop recording.

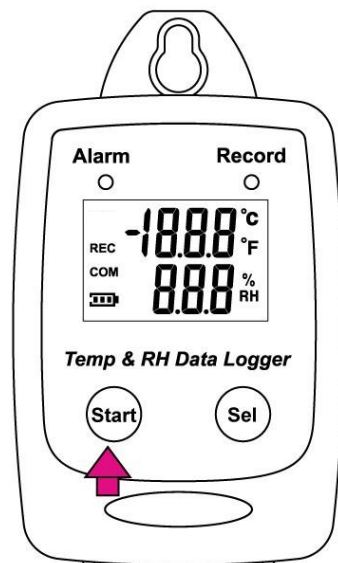

PC SOFTWARE INSTALLATION

Installation Requirements:

Minimum system requirements for the software:

-Pentium III - 500 MHz processor or equivalent with 128 megabytes of RAM.

Optimal Performance:

-Pentium 4 - 2.8 gigahertz processor or equivalent with 256 megabytes or RAM.

Operating System Requirements:

-Windows 2000

-Windows XP

-WIN 7

-WIN 8

-WIN 10

-WIN 11

- Insert the CD into the disk drive.

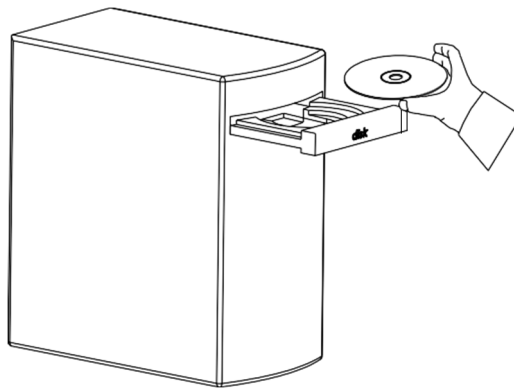

- Click Temp & RH Data Logger to start installation.

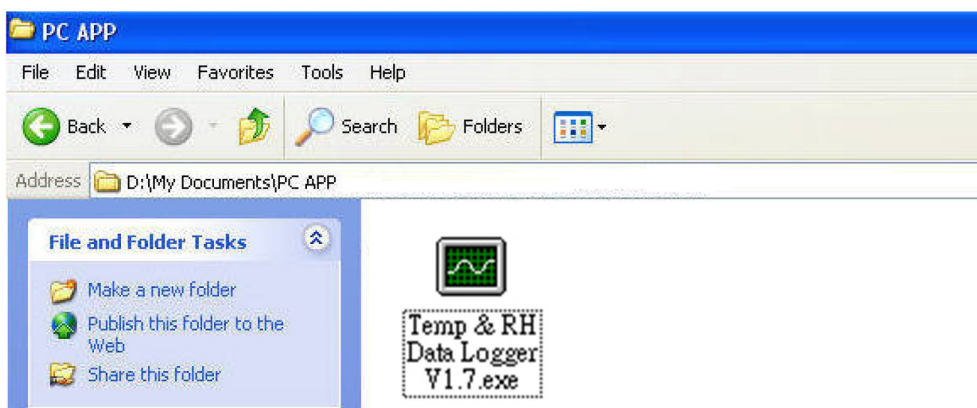

- Follow the steps on the Installation Shield Wizard and click NEXT to complete the installation.



USING PC SOFTWARE

- Start Window PC software.
- Click on All programs, Click on “Temp& RH Data Logger”
- Click on “Temp& RH Data Logger” V1.7



Connect Temperature/Rh Datalogger to PC

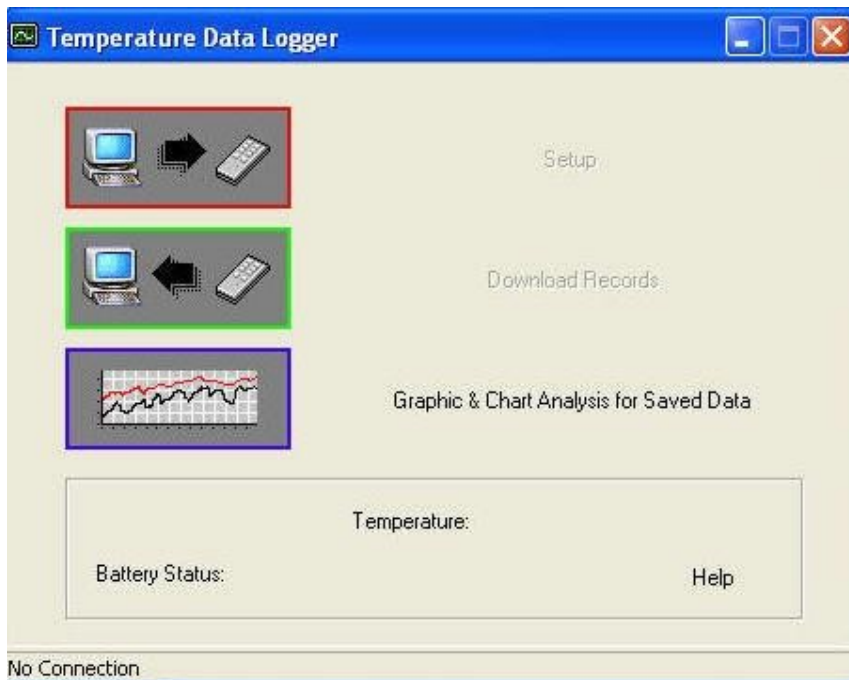

No Connection Screen

- Connect Temperature/Rh Datalogger to the PC with a USB cable.

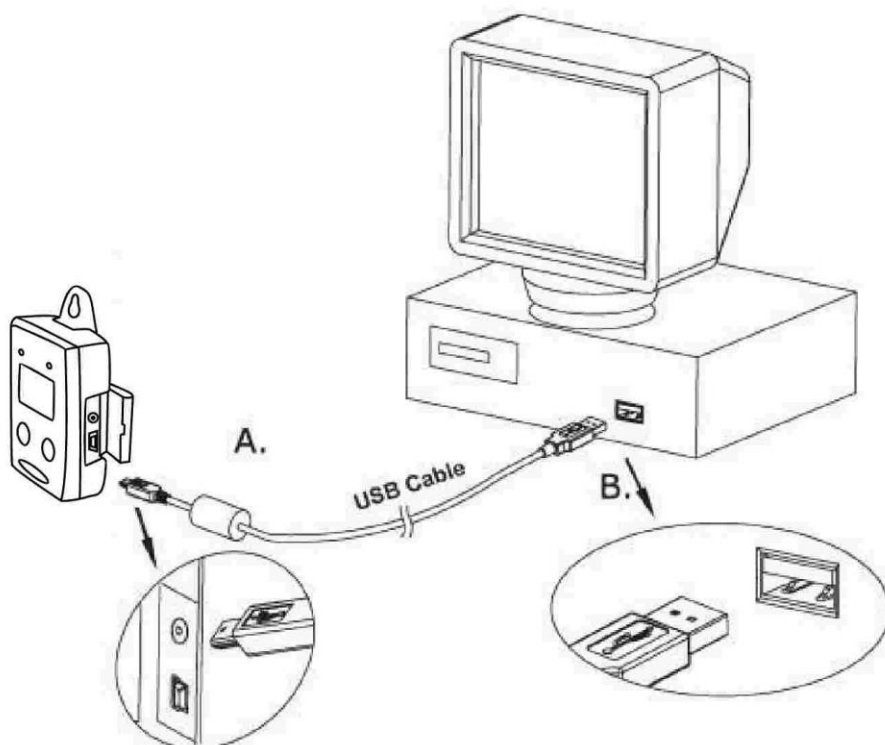

- Press Start for 2 seconds to turn on Temperature/Rh Datalogger.

Temperature/Rh Datalogger is now connected to the PC.

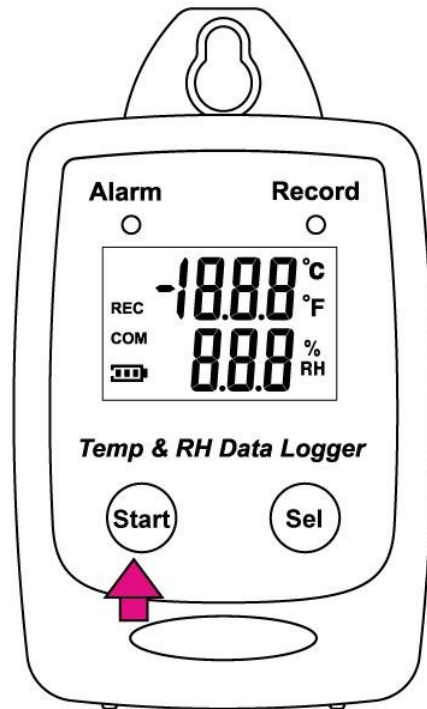

Connected Screen

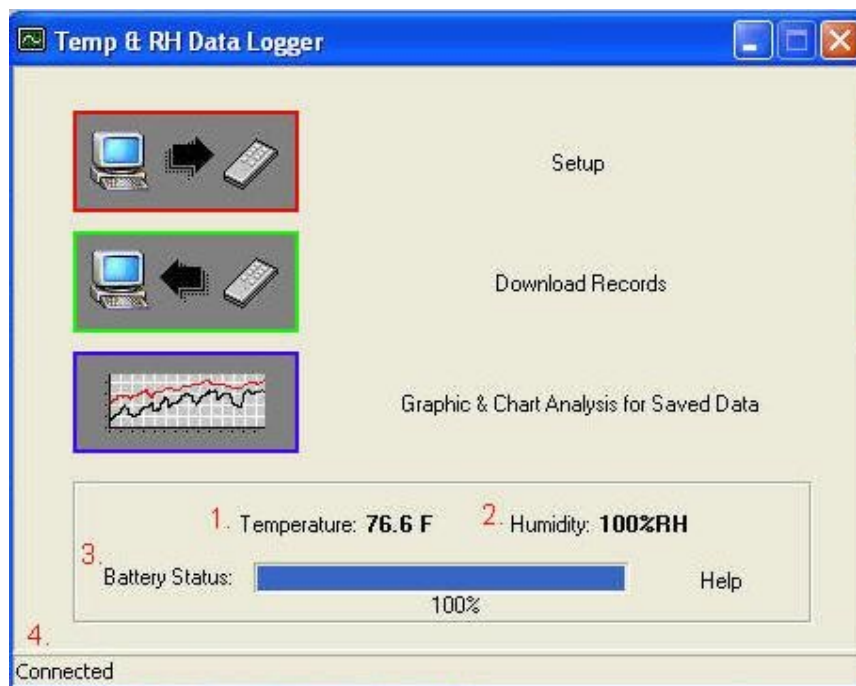

- If the datalogger is properly connected, these three values will show up.
 1. Temperature Reading
 2. Humidity Reading
 3. Battery Status
 4. Connection Status- “Connected”

Setup Screen

- Click “Setup” to enter the Setup screen.

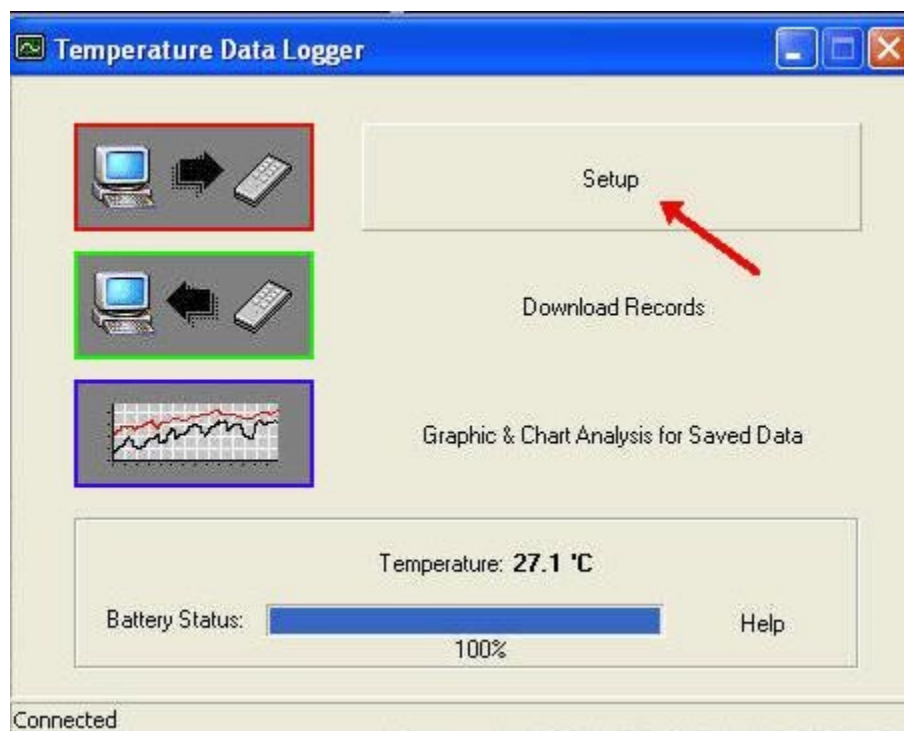

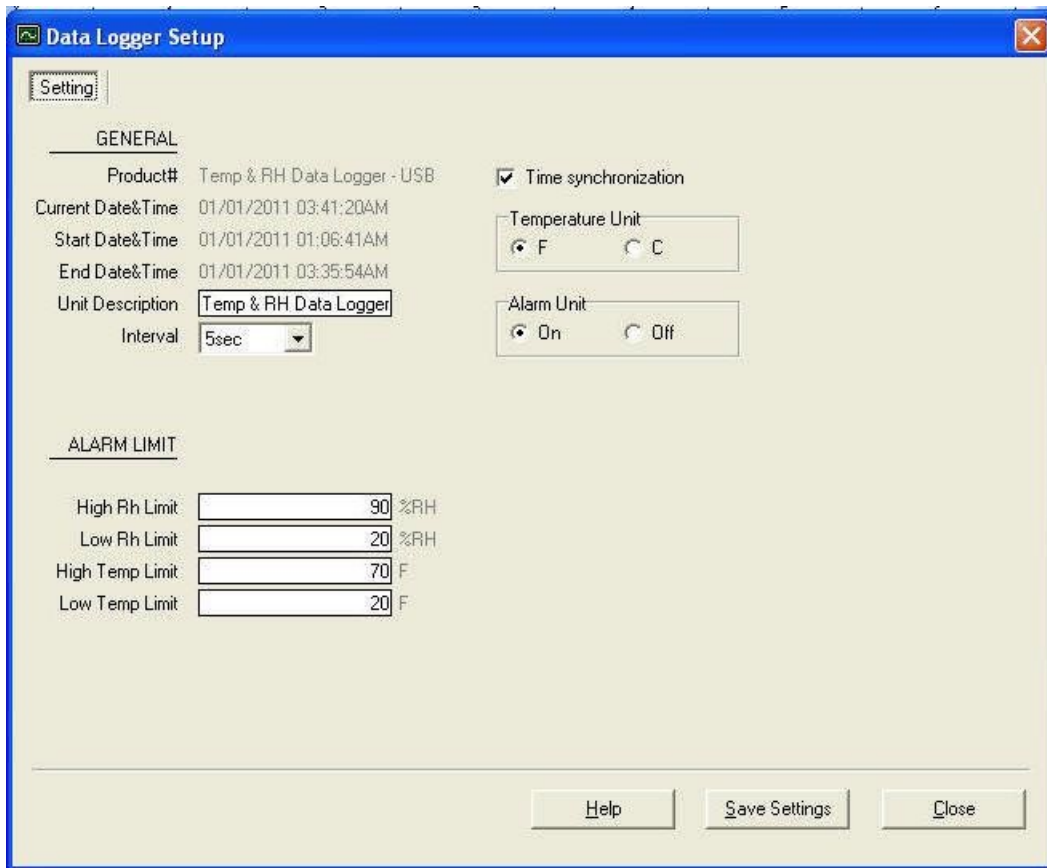

- The values in the white area can be changed by the user.
- The value in the grey area can not be changed by the user.
- Click "Save Settings" to save the values to the datalogger.

Download Records

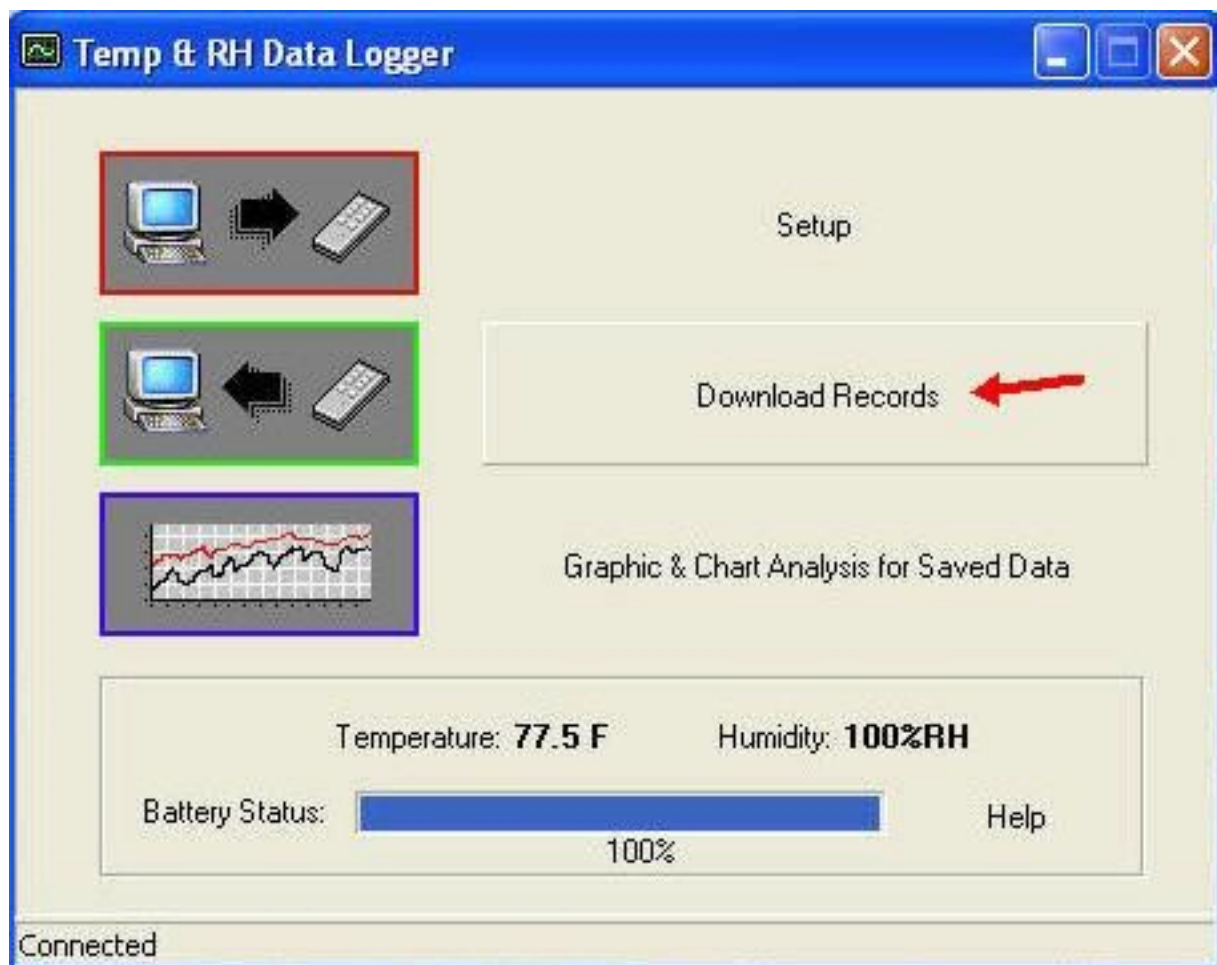

- Click Download to download the stored data.

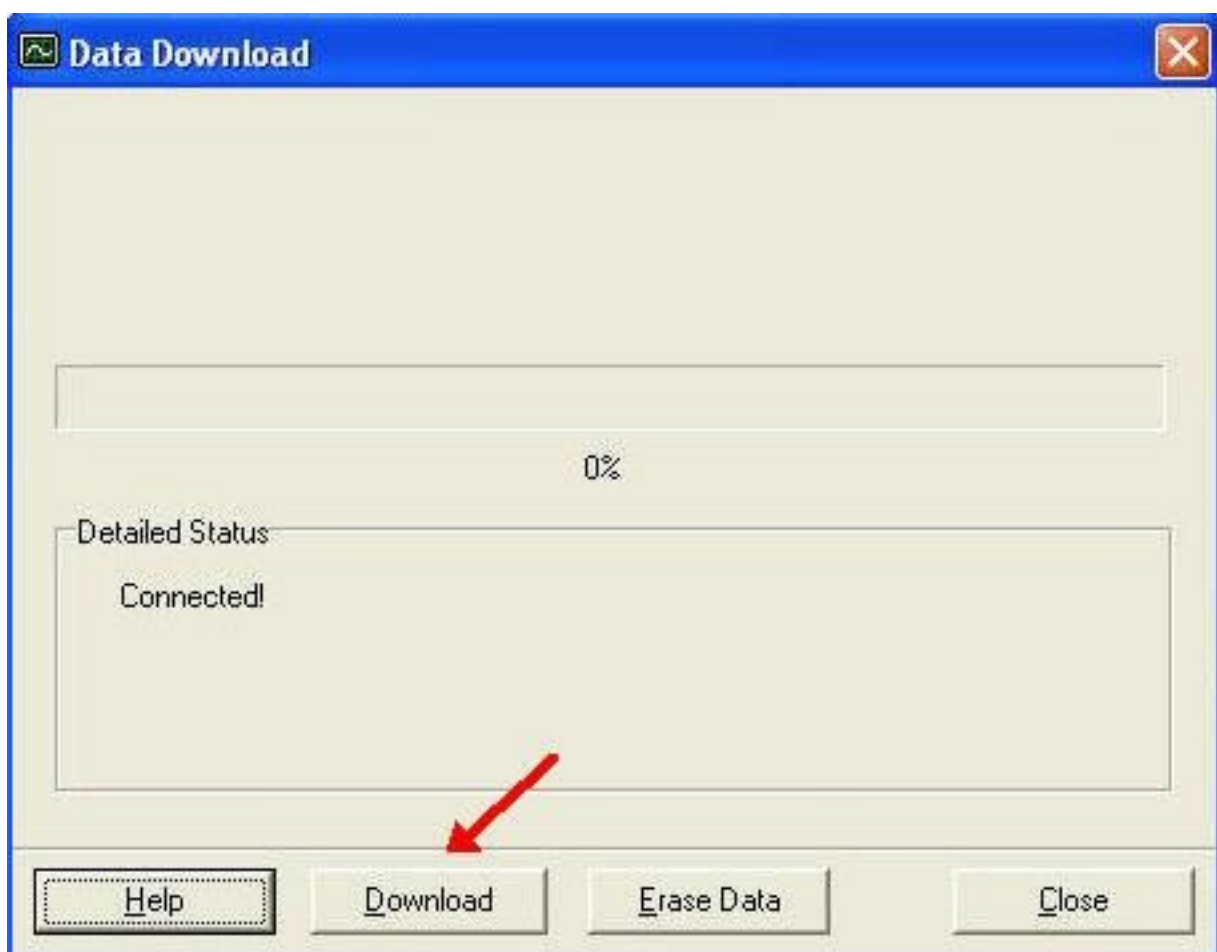

- Click “Download” to start the download.

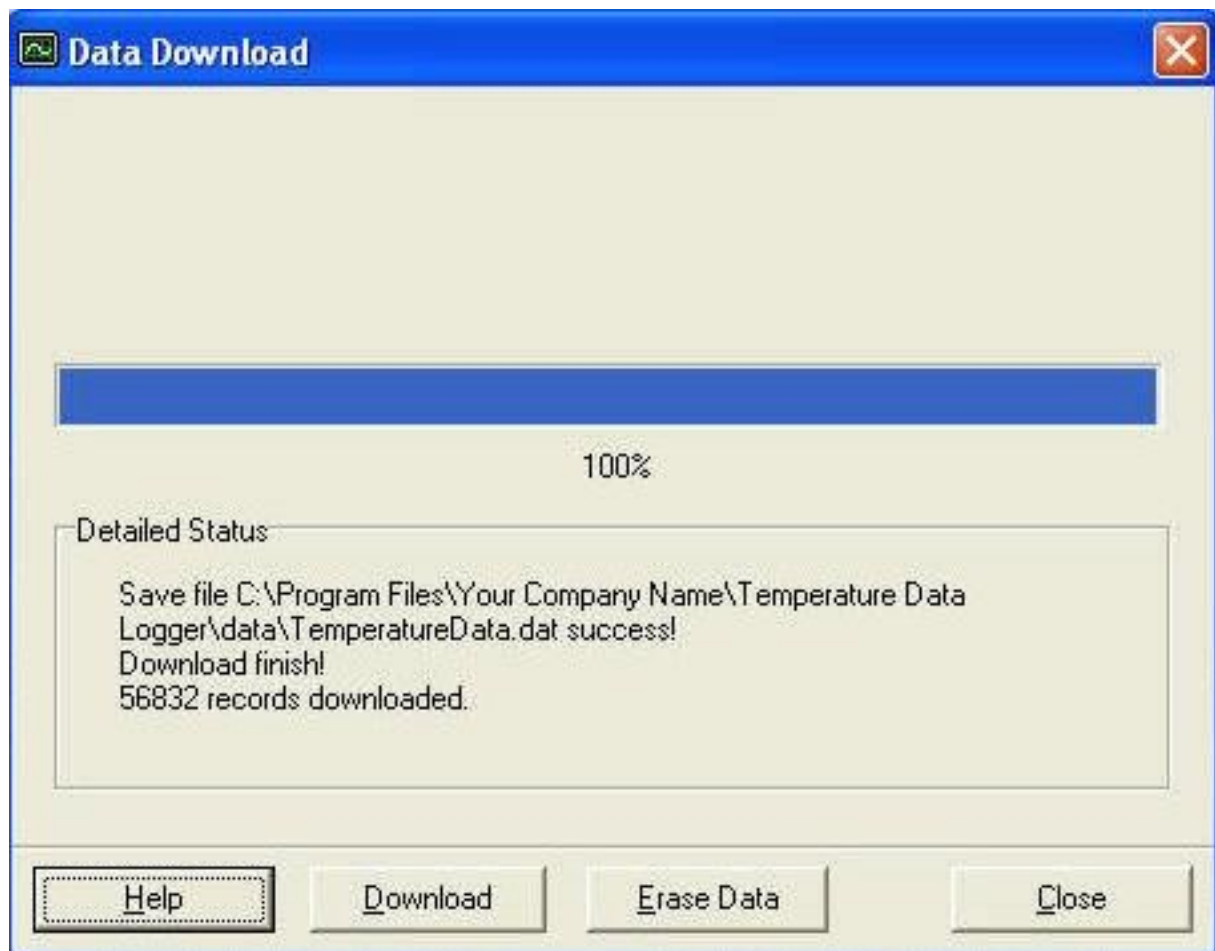

- Download Completed

Graphic & Chart Analysis

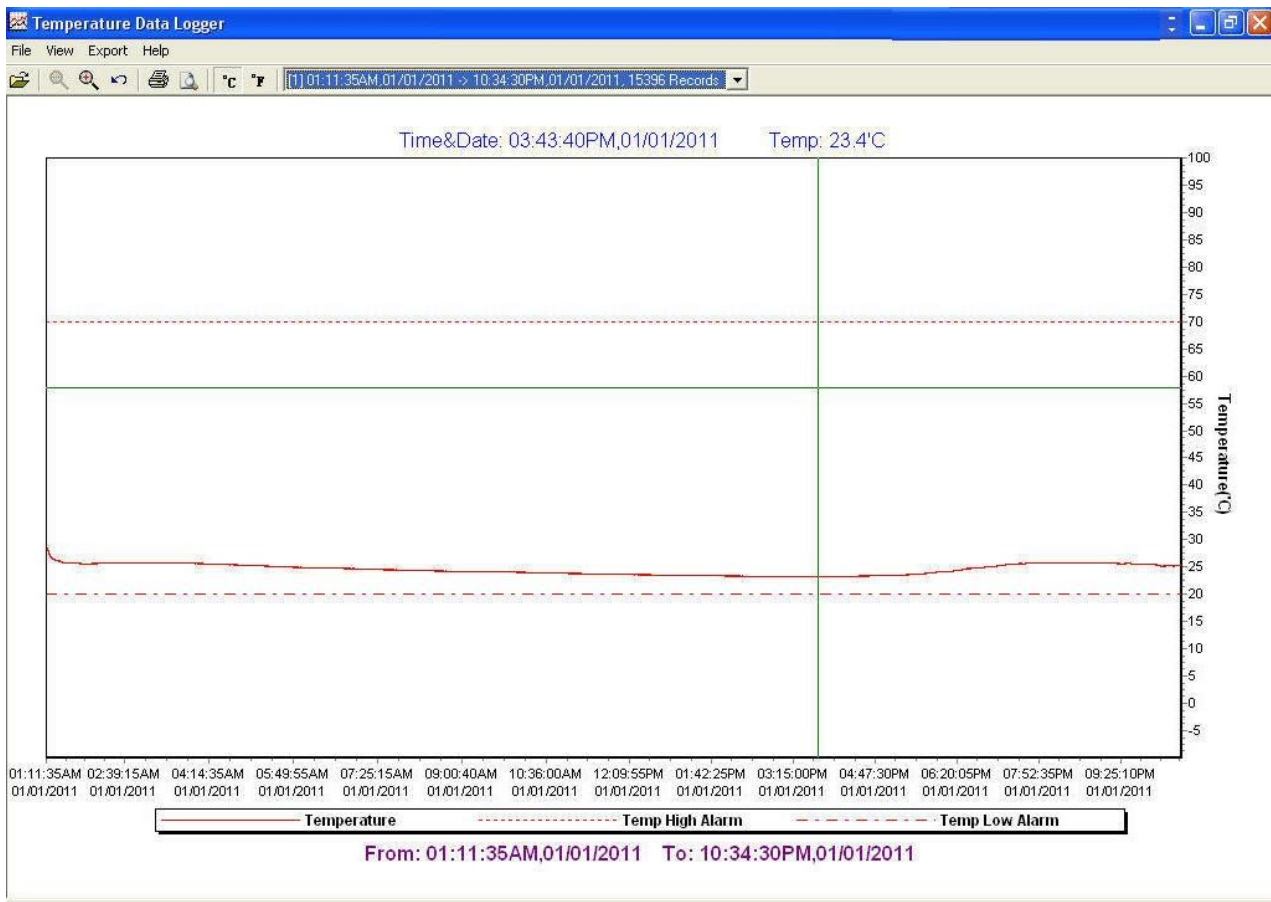

- Downloaded data will first be displayed in graph format.

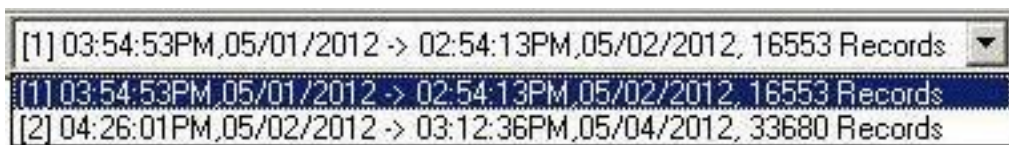

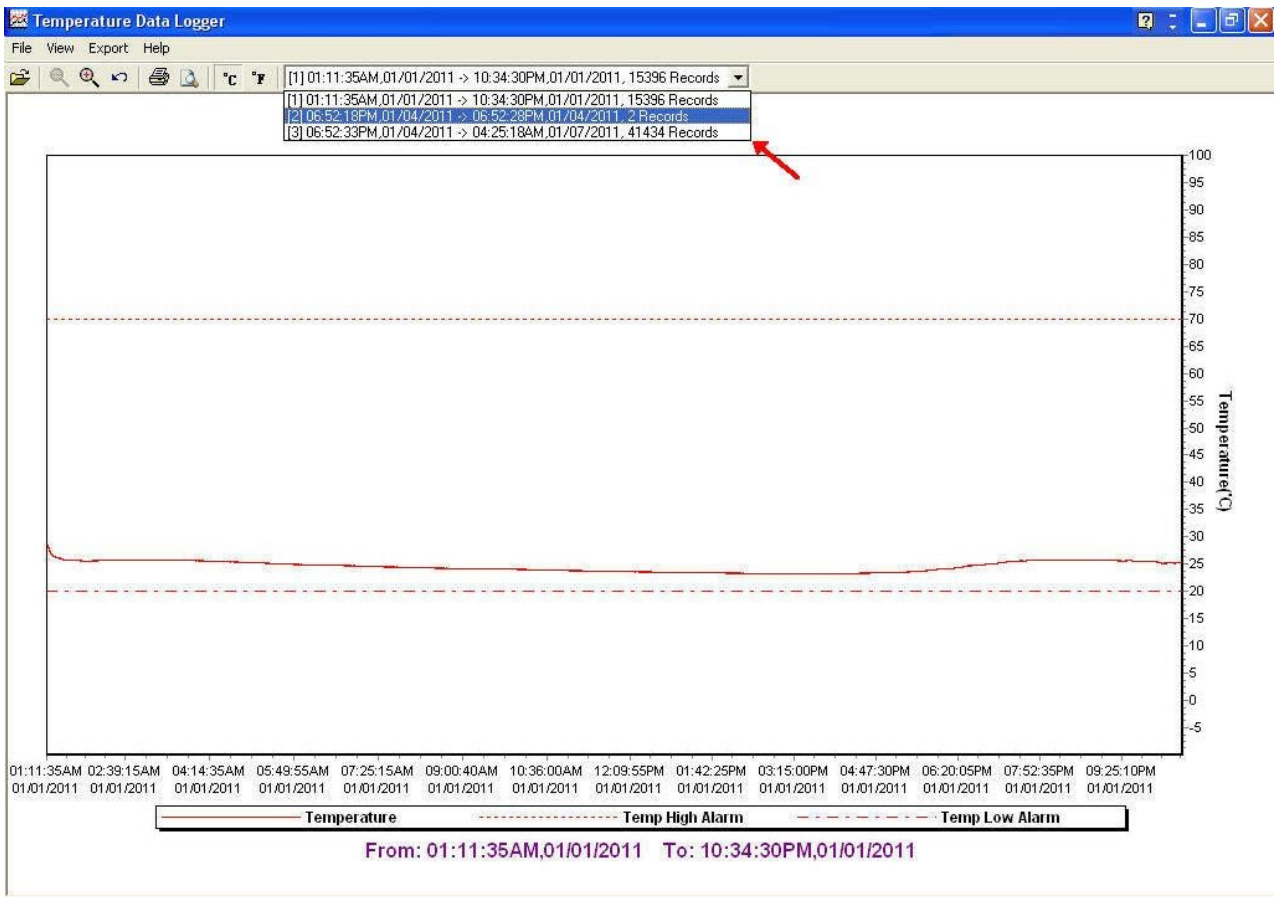

- Each data groups are listed according to the date of the sampling. Lowest group number represents earliest sampling date.

Data in Listing Format

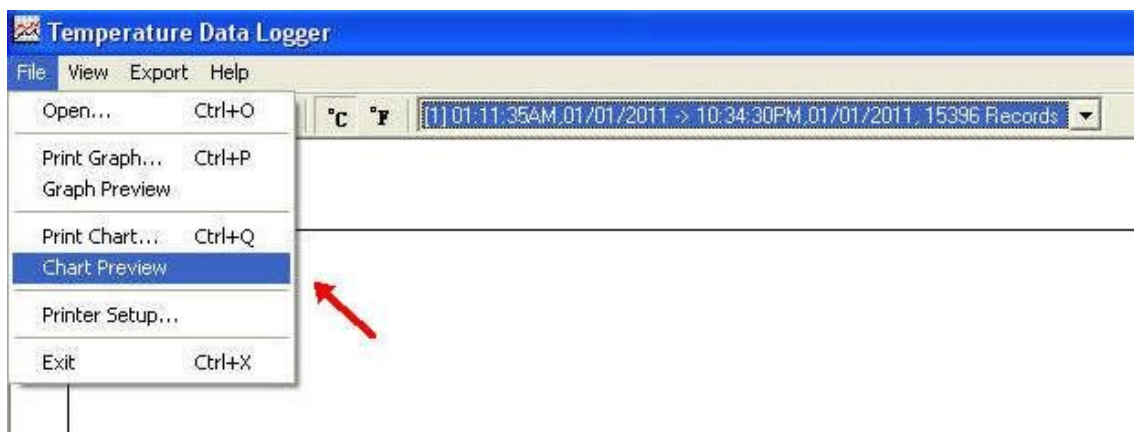

To display data in Listing format:

- Click File
- Click Chart Preview

Data Listing Format

Product Name: Temperature Data Logger
Description: STLogger Record Data
Start Data&Time: 06:52:18PM,01/04/2011
End Data&Time: 06:52:28PM,01/04/2011
Interval: 10 seconds
Record Count: 2
Temp Alarm High: 70.0 'C
Temp Alarm Low: 20.0 'C

<u>No.</u>	<u>Time</u>	<u>Date</u>	<u>Temp('C)</u>	<u>Alarm</u>
1	06:52:18PM	01/04/2011	33.2	
2	06:52:28PM	01/04/2011	33.5	

Data Export

- Select export data type: Text or Excel CSV.

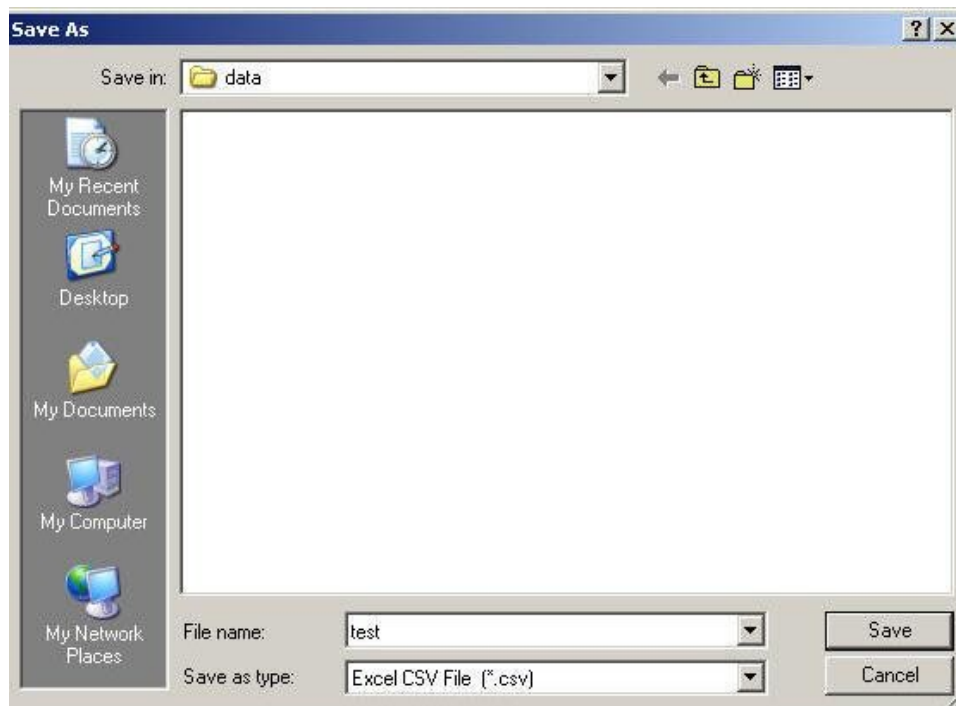
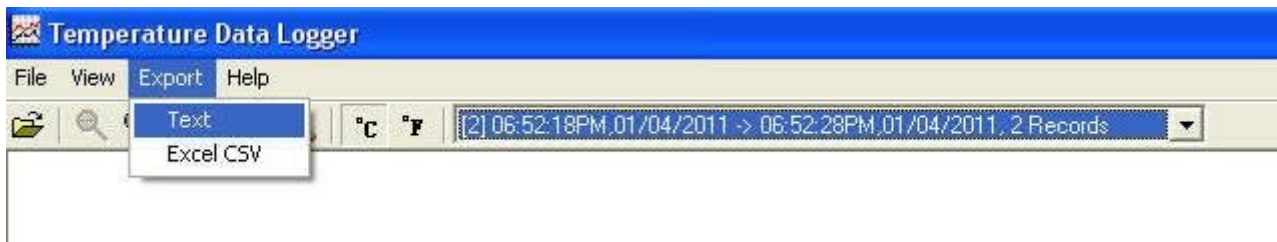

Click Save to save the file in .CSV/Txt format.



File Save

