



MODEL: AR3127

## High voltage insulation tester User's Manual



## Foreword

- Thank you for purchasing our company's high voltage insulation tester.
- This manual provides relative information on how to use this product and measurement functions of it as well as warnings on its use. To make the best use of this product's functions, read this manual thoroughly before use. Please keep this manual handy for ease of reference.
- Please do some test make sure the products is performing properly before measurement.

## Maintenance and warranty

### Maintenance:

1. Do not store or use the unit in following locations where the unit may be subject to:
  - a. Splashes of water or high levels of dust.
  - b. air with high salt or sulphur content.
  - c. Air with other gases or chemical materials.
  - d. High temperature or humidity (above 50°C, 90%,) or direct sunlight.
2. Do not disassemble the unit or attempt internal alterations.
3. Never use alcohol or thinner to clean the unit casing that will especially erode the LCD surface; just clean the unit lightly as needed with little clean water.

### Warranty

- 1). We provide one year guarantee.
- 2). We disclaim any liability due to: client's transportation damages; incorrect use or operation; manipulation, alterations or repair attempts.



### Statement

- a. We reserve the rights of upgrading and amending the design of the product as well as the manual updating, and the product is subject to change without any further notification.
- b. Dispose of battery should be in accordance with local laws and regulations.



## Other items

### Attentions:

1. The screen is vacant after turn the instrument:  
Check whether the battery is installed correctly. Open the battery door, check the symbol + - on the battery must accord with symbol on the battery compartment..
2. If the battery voltage lower than  $8.5v \pm 0.2v$  and the LCD displays low battery indication, please replace the battery to avoid the in-correct reading.  
Please read the page 11 of operation instruction for the battery replacement operation.
3. The connect way of test pin with alligator clip is like the following picture:

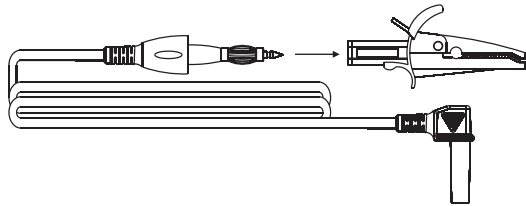

4. Remove the battery form the instrument if it is not required for extended periods of time in order to avoid damage to the battery compartment and the electrode resulting from a battery leakage.

## Contents

### 1. Before use notice

- Check-up------(01)
- Safety warning----- (02)
- Feature and function -----(04)
- Specifications -----(05)
- Diagram of the unit ----- (07)
- LCD display ----- (09)

### 2. Operation Instructions

- Preparation before measurement------(11)
- Voltage measurement------(13)
- Insulation resistance measurement----- (15)
- Timer measurement------(18)
- Polarization index measurement------(19)
- DAR measurement------(21)
- Data store/delete/read------(23)
- The use of green protect-wire----- (24)
- Connection with PC----- (25)

### 3. Other items

- Attentions------(31)
- Maintenance and warranty -----(32)
- Special statement------(32)

# 1. Before use notice

## Check-up

Carefully unpack your kit and ensure that you have the following items. In case that any items is missing or if you find any mismatch or damage, promptly contact your dealer.

- High Voltage insulation tester 1pcs
- User's manual 1pcs
- Alligator clip 2pcs
- Test wire 3pcs
- USB connection cable 1pcs
- Software CD 1pcs
- 1.5V C type alkaline battery 8pcs
- Soft bag 1pcs
- Screwdriver 1pcs

- 6). When USB transfer connects correctly, the software interface left side bottom corner will display “connect OK” . At the same time, the instrument will have a sound signal “di” to show connects success.
- 7).Click “Download” to start download data, Voltage and resistance's variation graph will create at the same time.

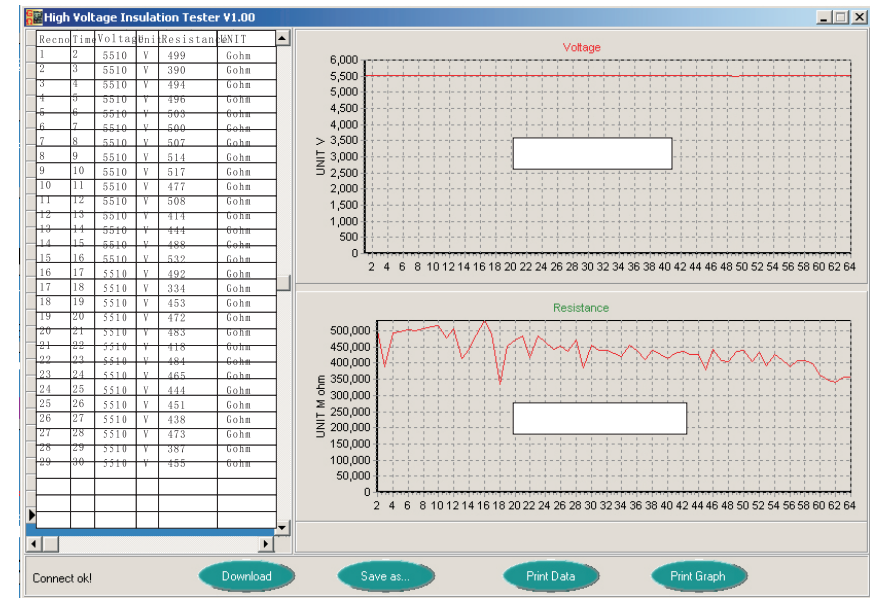

Operation Explanations

- 8).Save as: transfer the measured data to EXCEL file.  
Print Data: Print out the measured data.  
Print Graph: Print out the variation graph.

 **Caution:**  
The data shown in the operation instruction are merely an example to illustrate, please refer to the value obtained in your practice.

#### 4. Software

- Start the user desktop shorter link to start the software, (also, user can start through “Start => Program” , the operation interface as below:

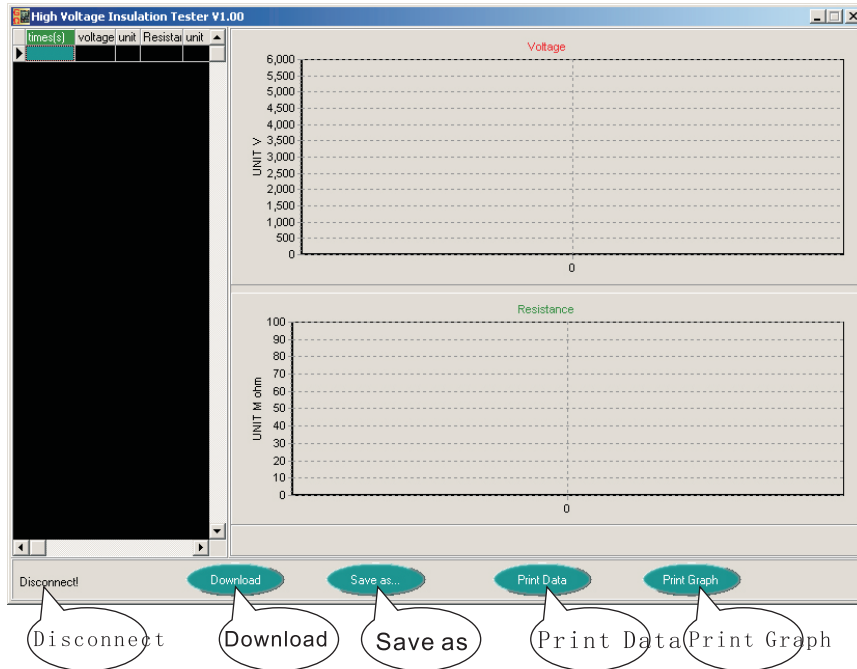

- 5). Turn on the high voltage insulation tester, connect the other side of USB transfer wire to high voltage transmit port.

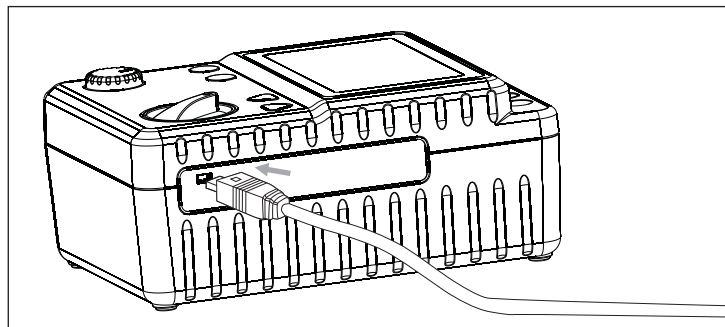

### Safety warning

Designed to following safety standards:

- IEC 61010-1 CAT. III 600V pollution level: 2  
CAT. I 5000V pollution level: 2
- IEC 61010-031 (test wire)
- IEC 61326-1 (EMC)
- IEC 60529 (Ip40)

⚠ Waring:

Electricity is dangerous and can cause injury/ death. For use the instrument correctly and safely, please read this manual carefully and follow the instructions. If you not quite sure how to proceed, stop and take advice form qualified person.. This instruction manual contains warning and safety rules which user be observed by the user.

The symbol "⚠" in this manual have three meanings, please pay attentions with the operation with "⚠" symbol.

- ⚠ Danger--That conditions/operations likely to cause serious or fatal injury.
- ⚠ Warning--That conditions/operations can cause serious or fatal injury.
- ⚠ Caution--That conditions/operations can cause a injury or instrument damage.

⚠ Caution

- Before testing, make sure to select proper range.
- After testing, please turn off the tester.





**⚠ Danger**

- Do not measure if the voltage is above 600V.
- Do not test at flammable / explosive hazard.
- Do not measure if the unit or your hand is wet.
- Do not go beyond the range of the tester
- Do not open the battery door when you are measuring.
- Do not touch any naked lead when you are measuring
- Make sure to turn off the unit after measurement.

**⚠ Warning**

- The tester must be operated according to this manual by qualify person who have passed the training.
- Do not open the case while testing. If the tester not working properly, please return for repair.
- Do not replace the batteries in a humidity condition.
- Make sure the wire firmly connected to the tester.
- Make sure to turn of f the power before open the battery door.
- Check the tester regularly, do not operate if the tester is not normal(such as lead wire is cracked, the case broken etc.)
- Do not attempt any alterations. Please contacted your dealer if the tester need to be repaired.

**Symbol:**

	Danger of possible electric shock
	Instrument with double or reinforced insulation
	DC
	AC
	Ground terminal

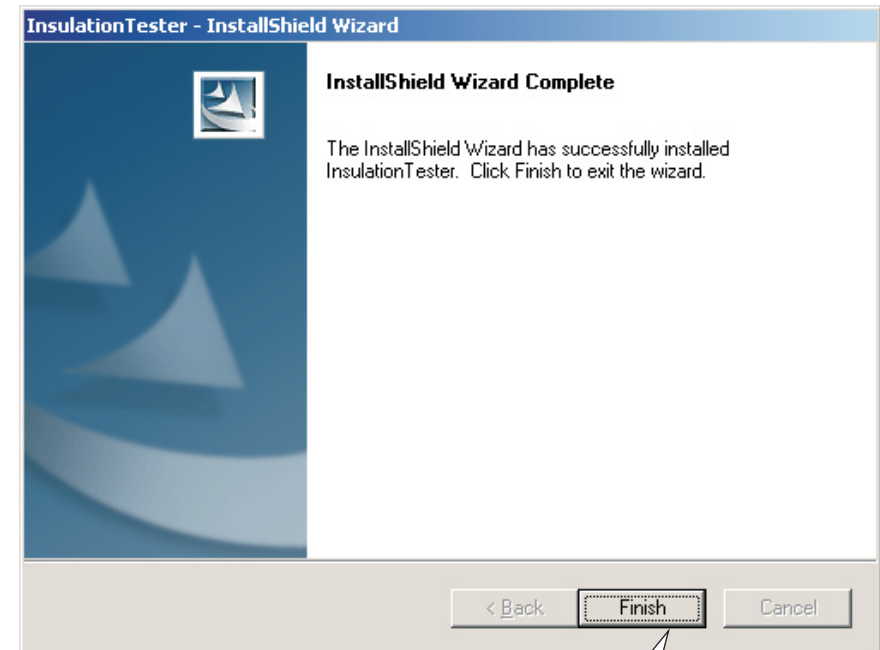

Figure 4

3). Use USB transfer wire connect the insulation tester to with PC spare port. Like the followed picture 5:

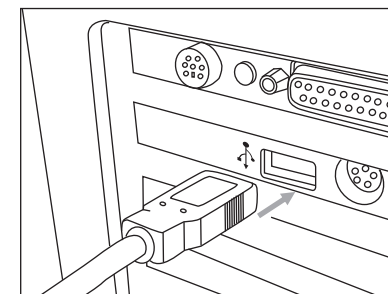

Figure 5

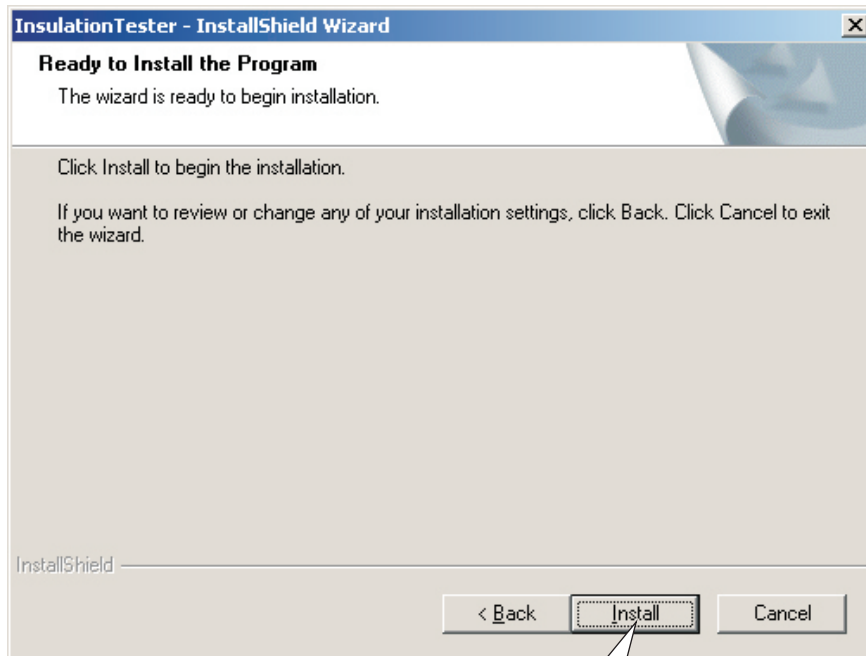

Figure 3 Install

- Click “Finish” to complete the installation, the shortcuts will create on desktop automatically.



**Caution:**

If you want to uninstall this program, please open control panel, then open add/delete program, select “Insulation tester” in the list, and click “delete” button to remove the software.

## Features and functions

- Auto- discharge function, the operation is safe.
- Adjust the related voltage each 50V(250~5000V)
- Bar graph to display tested result.
- Live circuit warning symbols with audio sounds.
- Auto- power off function (if there is no operation for 10 min)
- Timer measurement function (automatically performs during the set time)
- Low voltage indication
- PI measurement (Polarization index measurement)
- DAR measurement (Absorption rate measurement)
- USB port data transfer between instrument and PC.
- LCD Back-light
- 12V DC input interface: (DC adapter: 12V/1A)
- Data Store / Recall / Delete function

Need To Know Before Use

## Specifications:

### 1. Insulation resistance tester:

Rated voltage	250~950V	1000~1950V	2000~3950V	4000~5000V
Test range	0.0~999M $\Omega$	0.0~1.99G $\Omega$	0.0~99.9G $\Omega$	0.0~1000G $\Omega$
Open circuit voltage	DC 250~500V $\pm 50V$ DC 500~950V $\pm 10\%$	DC 1000~1950V $\pm 10\%$	DC 2000~3950V $\pm 10\%$	DC 4000~5500V $\pm 10\%$
Short-circuit current	Approx. 1.3mA			
Accuracy	0~99.9G $\Omega$ : $\pm 5\%rdg \pm 3dgt$ above 100G $\Omega$ : $\pm 20\%$			

### 2. Voltage tester:

#### 30~600V (Resolution 1V)

	DC Voltage	AC Voltage
Measuring range	$\pm 30 \sim \pm 600V$	30~600V (50/60Hz)
Resolution	1V	
Accuracy	$\pm 2\%rdg \pm 3dgt$	

- Enter your user name and company and, click “Next” to enter next step, as shown in picture 2:

The screenshot shows a software installation wizard window titled "InsulationTester - InstallShield Wizard". The "Customer Information" section is selected, with the instruction "Please enter your information." Below this, there is a prompt: "Please enter your name and the name of the company for which you work." There are two text input fields: "User Name:" containing "PAG02" and "Company Name:" containing "ARCO". At the bottom right, there are three buttons: "< Back", "Next >", and "Cancel". A callout bubble points to the "Next >" button.

Figure 2

Next

- Setup type selection, select the defaulted setup (complete) type, click NEXT to enter Next step, as shown in picture 3.



## Connection with PC

- 1). System requirement of computer configuration:
  - CPU: Pentium III 600MHz or better;
  - One spare USB port.
  - Monitor resolution 800\*600, real color or better.
  - 8 Mb Ram spare spaces or larger.
  - 50 Mb hard disk spare spaces or larger.
  - Operation System: Microsoft Windows 98/ ME/ 2000/ XP home/ XP Professional 32Bit.
- 2). Software installation.
  - Place the software in your CD driver and double click the “Setup.exe” program icon. Enter the program install shield wizard interface, click “Next” to next step. Like the followed picture 1.

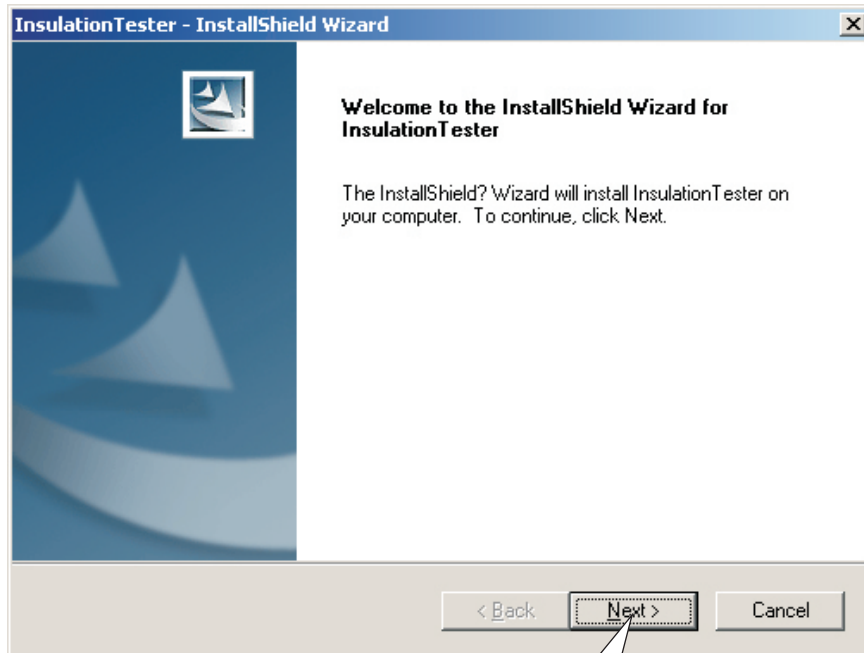
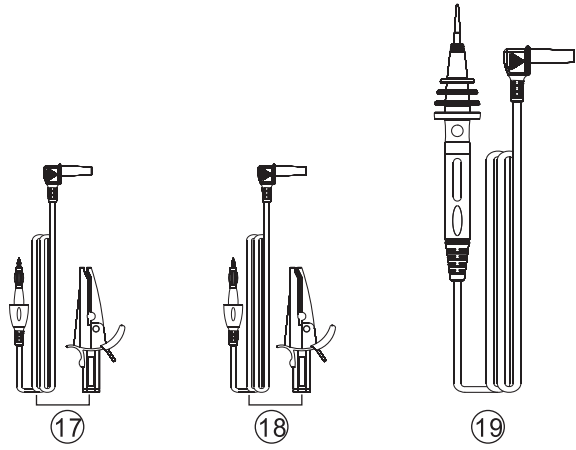
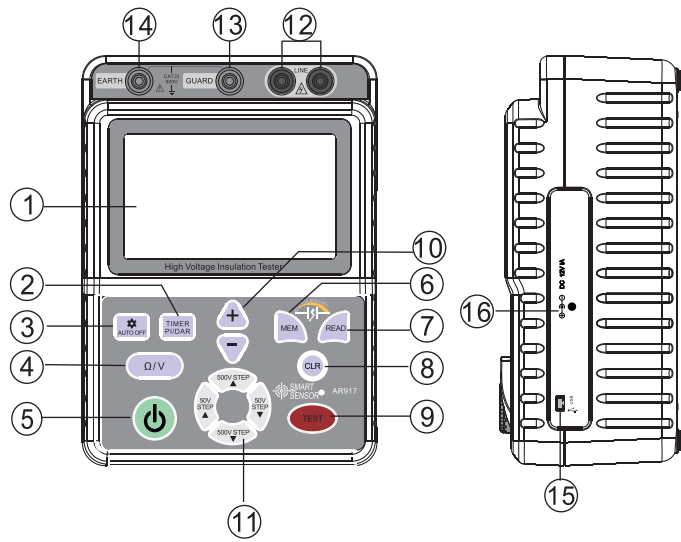

Figure 1

## 3. Technology parameter:

Technology parameter	Technology index
Display	Liquid crystals display Max. 999counts (1000 counts only at 1T is displayed) Bar graph/ max. 36 point.
Over range indication	OL mark appears on insulation resistance range. LO/HI mark appears on voltage's range.
Sample rate	0.5~ 10 times/sec
Operable altitude	2000m or less above sea level (in door use)
Operation circumstance	Temperature 0~40C, humidity <= 85%
Storage circumstance	Temperature -20~ 60C, humidity <= 90%
Overload protection	Insulation resistance range: AC 1200V/ 10 second Voltage range: AC 720V/ 10 second.
Voltage resistance	AC8320 (50/60Hz)/ 5 second (between electrical circuit and enclosure)
Insulation resistance	1000M of more/ DC 1000V (between electrical circuit and enclosure)
Power supply	1.5V C type alkaline battery*8pcs (or DC adapter 12V/1A)
Current consumption	Approx. 800mA (max)/ 40mA(Normal status)
Battery's life- span	Approx. 15 hours
Dimension	153x 213x 95mm
Weight	1027g (without batteries and test wires)

## Diagram of the unit





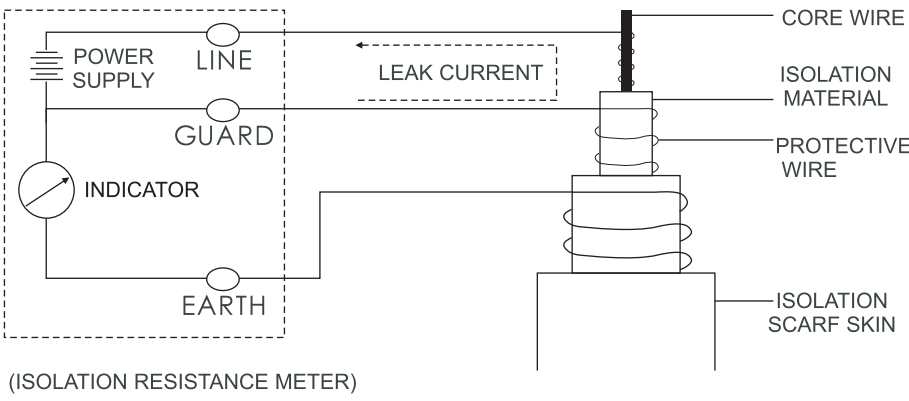
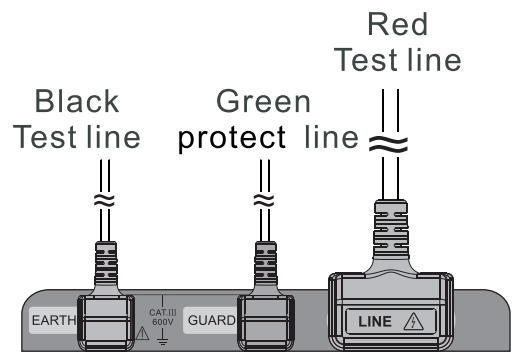

## The use of green protect- wire











Connect the green protect- wire to GUARD terminal. It only is used to measure the insulation resistance of cable. Nip the shield like during the measurement to reduce the effect of leakage current (please reference before test instruction to understand other operation). Connect the wires like the followed picture:



Operation Explanations

## Data store/delete/read

1. Date Store: Push the "  " button. Then the "  " will display on the LCD and this unit start to store the test data once per second.
2. Data Delete: Push the "  " button. Then the "CLR" will flash once on the LCD, which indicate all the stored data has been deleted.
3. Data Read: Push the "  " button. Then one stored data (Include the memory No/ related voltage/ test result) will display on the LCD.  
If you want to read another data, push the button again and again...

1. LCD display.
2.  : Time set/PI/DAR Selection.
3.  : Back light button.
4.  : Voltage/Resistance Selection button.
5.  : Power ON/OFF button.
6.  Data Store button.
7.  : Data Read button.
8.  : Data Delete button.
9.  :Test button.
10.  :Test time adjust button.
11.  :Voltage adjust button.
- 12.Red high voltage test wire socket.
- 13.Green protect test wire socket.
- 14.Black test wire socket.
15. USB Interface
- 16.DC input interface (12V/1A)
- 17.Black testing wire and alligator clip.
18. Green protective testing wire and alligator clip.
19. Red Hi- volt testing wire.



### Caution

The data in the diagram of the unit is a simple instruction. Read the operation to get a detail operation guidance.

## LCD Display

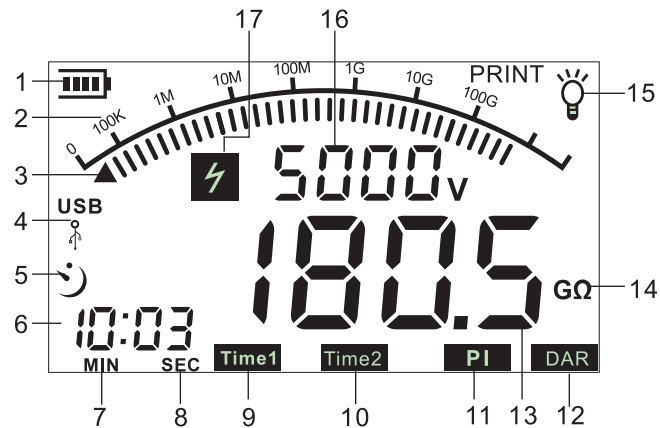

1. : Battery mark shows current residual battery power. Has following 5 grades:  
 : battery is sufficient  
 : battery is comparative sufficient  
 : battery is nearly deficient  
 : battery is nearly exhausted, need to have a replacement  
 : battery is exhausted completely
2. The symbol of the range of the insulation resistance
3. Dynamic bar graph display section of insulation resistance
4. : USB data transfer symbol
5. : Set time count down symbol
6. Timing display section

## DAR(Absorbing rate) measurement

1. Please check "INSULATION RESISTANCE" if you want to know the first and second procedure in detail.
2. Press the "" button for three times. Then the mark " " will display on the LCD. LCD will display like the followed picture:

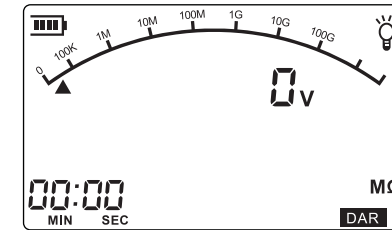

3. Press the " " button to perform a DAR (Absorbing rate) measurement of insulation resistance. Then the buzzer will sound, and the " " and " " will flash at the first 15 seconds. After that time, the " " and " " will flash.
4. When finish the measurement, the high voltage will get off and the sound of buzzer stop. The result will display on the LCD. LCD will display like the followed picture: [Absorbing rate= Resistance of 1 minute/ Resistance of 15 seconds]

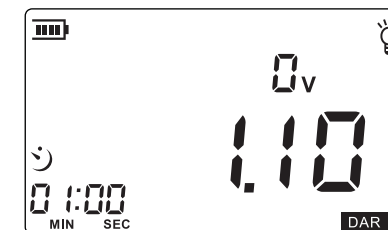

4. When the measurement is completed at TIME2, the high voltage light get off, the sound of the high voltage stop, turn test button back to the original position anticlockwise, the result will be displayed like the followed picture:

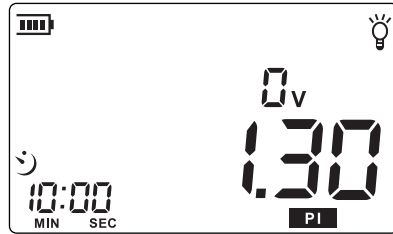

5. Polarization index measurements usually set TIME 1 to 1 min. set TIME2 to 10min.

$$\text{Polarization index} = \frac{\text{Resistance value in 10 min (TIME2)}}{\text{Resistance value in 1 min (TIME1)}}$$



Polarization index	4 or more	4- 1.5	1.5- 1.0	1.0 or les
Criteria	Very good	Good	Not very good	Very bad

7. **MIN** :Minute symbol
8. **SEC** :Second symbol
9. **Time1** :Timers 1
10. **Time2** :Timers 2
11. **PI** :Polarization index
12. **DAR** :Absorbing rate
13. Voltage/ insulation resistance display.
14. Resistance unit
15. :Backlight symbol.
16. Voltage display section
17. :High voltage warning symbol.

## 2. Operation instructions

### Preparation before measurement

#### 1. Checking the battery voltage & battery replacement:

- Press the  button to turn on the unit
- When the battery mark shown at the upper left on the LCD is “”, the battery is almost exhausted. Replace the batteries to proceed to measurement. The instrument operates properly even if under such a low battery, and it may not affect on the accuracy. When battery mark is “”, the battery voltage is below the lower limit of the operating voltage. So the accuracy cannot be guaranteed.

#### C. Battery replacement:



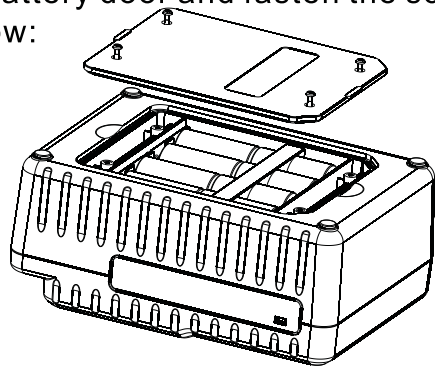



- Replace all the test line after you turn off the instrument.
- Uninstall four screws in the bottom and open the battery door.
- Replace all old batteries with new batteries. Please note the polarity.
- Install the battery door and fasten the screws. As the picture below:



#### Caution:

Remove the batteries if the tester is not required for a extended periods in order to avoid damage to the battery compartment and erosion resulting from a battery leakage.

### Polarization index measurement

- Please check “INSULATION RESISTANCE” if you want to know the first and second procedure in detail.
- Press the “” button, TIME1 mark will displayed, and then press  or  button to set time, for example: 1 min; Press the “” button again TIME2 mark will displayed, then press  or  button to set time, for example: 10 min. LCD will display like the followed picture:

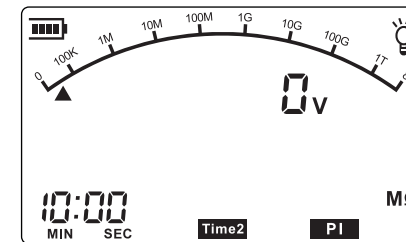

- Connect the test pin/clip to the insulation material under test, press test button to perform Polarization index measurement of insulation resistance. The buzzer will sound, the **Time1** and **PI** will flash when measure insulation resistance at “Time1” ; the **Time2** and **PI** will flash when measure insulation resistance at “Time2” . LCD display like the followed picture during the measurement:

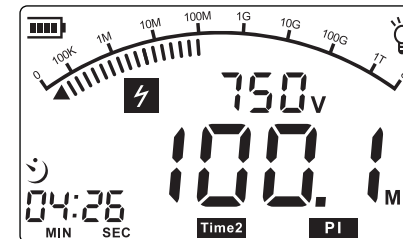

5. Measurement is automatically finished at the set time, the high voltage light get off, the sound of the high voltage stop, LCD will display like the followed picture:

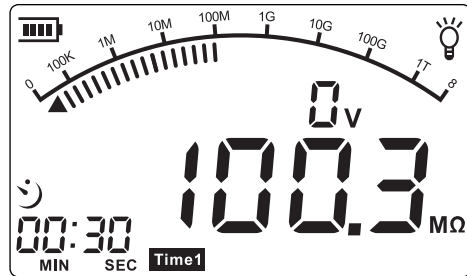

**Caution:**  
Press  $\oplus$  or  $\ominus$  button, time can be set at every 5sec form 00:00 to 01:00, after that rang time can be set at every 30sec.

## 2. Connecting test wires:

Insert the test wire firmly to the connector terminal on the instrument;

Connect the red test wire to “Line” terminal;

Connect the black test wire to “Earth” terminal;

Connect the green guard wire to “Guard” terminal;

The connect method like the picture below:

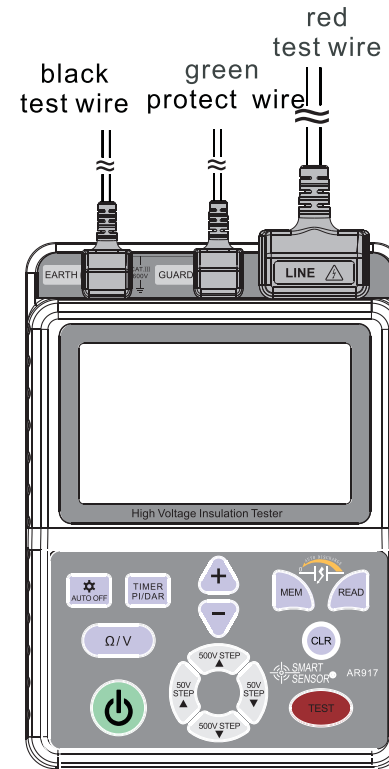

## Voltage measurement(30~600V)

### ⚠ Danger

- Do not make measurement on a circuit above AC/ DC 600V
- The user maybe hazard when testing installation that has a large current capacity, please do not touch any bare wire at this time.
- Do not make measurement with the battery cover removed.

- 1.Connect the red test wire and black test wire to reciprocal terminal socket.
- 2.Turn on the unit. Then press  $\Omega/V$  button to Voltage measurement mode. If the red and black test wire don't connect, LCD display like the follow picture:



## Timer measurement

This is a function to conduct a test automatically at any set time.

- 1.You can consult INSULATION RESISTANCE if you want to know th first and second procedure in detail.
- 2.Press the “  $\text{TIMER P/DAR}$  ” button and TIME1 mark will be displayed.
- 3.Press  $\Delta$  or  $\nabla$  button to set up time, for example, 30 second. LCD will display like the followed picture at this time:

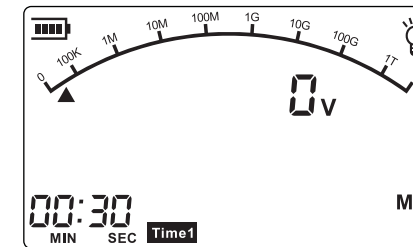

- 4.Press the test button to perform a timer measurement of insulation resistance, the buzzer will sound and the “  $\text{Time1}$  ” will flash. LCD will display like the followed picture during the measurement:

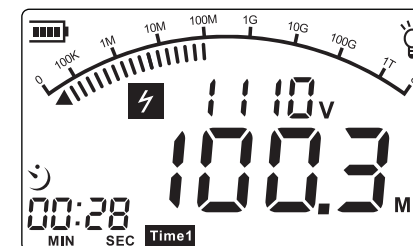



**⚠ Danger**

- Do not touch the circuit under test immediately after testing. Capacitance stored in the circuit may cause electrical shock.

4. The test principle of the insulation resistance: Resistance value can be obtained by applying a certain high voltage to the resistance and measure the following current.

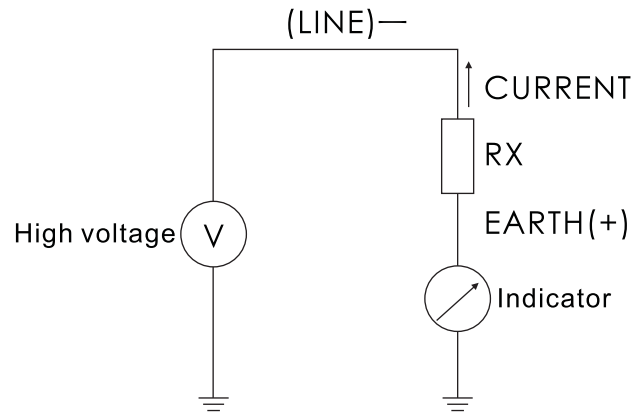

**Caution:**

1. For safety of measure and instrument, When the insulation resistance less than  $50M\Omega$ , please set the related voltage less than 500V to make the measurement.
2. If the related voltage is above 2000V, it is normal state if the unit generate a slight squeak when we test the material of small resistance.
3. Before turn off the unit, make sure the test wires have been taken away.

3. Connect the red or black test pin to the pole, if the beam is dim you can press the “” button and open the back light. The LCD display have three instances at this time:

Connect the red pin which test direct voltage to +, connect the black to -, the LCD displayed like the picture below:



Connect the red pin which test direct voltage to -, connect the black to +, the LCD displayed like the picture below:

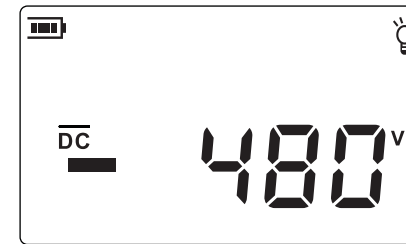

The LCD displayed like the picture below when test AC:

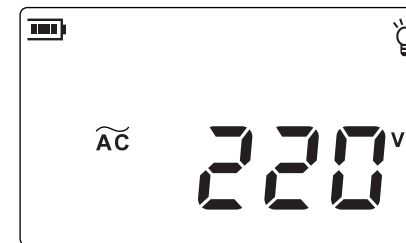

4. Remove the test pin from the tested parts firstly after measurement, and then press the button to turn off the unit.

## Insulation resistance measurement

### ⚠ DANGER

- Make sure to check with a high voltage detector that there is no electrical charge exists on the circuit under test.
- Be sure to put on a pair of insulated gloves for high voltage.
- Do not make measurement when thunder rumbling.
- Do not make the measurement with the battery cover removed.

### ⚠ Caution

- Do not make measurement when the live circuit wiring is active.

1. Connect the red test wire and black test wire to reciprocal terminal socket.
2. Setting the proper related voltage according to the content of insulation material, (you can take a try follow the sequence 500V/ 1000V/ 2500V/5000V if you do not know the resistance range; You can increase or reduce each 50V or each 500V). For example, 2500V like the following picture:

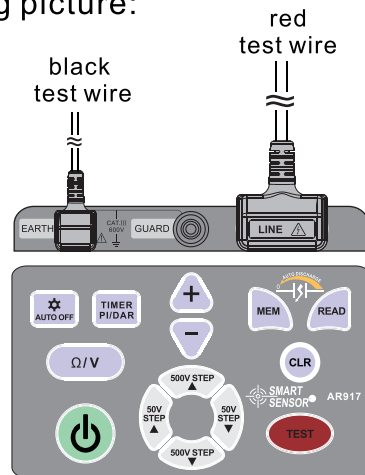

3. Connect the test pin/clip to the unit under test, press the test button to measure, the buzzer will sound continuously and the high voltage light will be activated. LCD displayed like the followed picture during the testing:

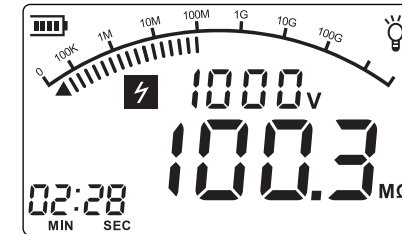

3. Press test button again, the instrument will discharge the high voltage automatically, and the high voltage light and the sound of the high voltage will stop. Only remove the test wires when LCD display 0V. The LCD will display the tested time and insulation resistance as the picture below:

