

Instruction Manual

**HI 8014 • HI 8915
HI 931000**

Portable pH Meters

Dear Customer,

Thank you for choosing a Hanna product. Please read this instruction manual carefully before using the meter. This manual will provide you with the necessary information for a correct use of the instrument.

If you need additional technical information, do not hesitate to e-mail us at tech@hannainst.com.

These instruments are in compliance with the CE directives.

WARRANTY

All Hanna Instruments **meters are warranted for two years** against defects in workmanship and materials when used for their intended purpose and maintained according to instructions. **Electrodes and probes are warranted for six months.**

This warranty is limited to repair or replacement free of charge. Damages due to accident, misuse, tampering or lack of prescribed maintenance are not covered. If service is required, contact the dealer from whom you purchased the instrument. If under warranty, report the model number, date of purchase, serial number and the nature of the failure. If the repair is not covered by the warranty, you will be notified of the charges incurred. If the instrument is to be returned to Hanna Instruments, first obtain a Returned Goods Authorization number from the Customer Service department and then send it with shipping costs prepaid. When shipping any instrument, make sure it is properly packaged for complete protection.

TABLE OF CONTENTS

PRELIMINARY EXAMINATION	3
GENERAL DESCRIPTION	3
FUNCTIONAL DESCRIPTION HI8014	4
SPECIFICATIONS HI8014	5
FUNCTIONAL DESCRIPTION HI8915	6
SPECIFICATIONS HI8915	7
FUNCTIONAL DESCRIPTION HI931000	8
SPECIFICATIONS HI931000	9
OPERATIONAL GUIDE	10
pH CALIBRATION	14
pH VALUES AT VARIOUS TEMPERATURES	18
TAKING REDOX MEASUREMENTS	18
TEMPERATURE CALIBRATION	19
mV OUTPUT	19
DISPLAY CODES GUIDE	19
ELECTRODE CONDITIONING AND MAINTENANCE	20
BATTERY REPLACEMENT	23
ACCESSORIES	24
CE DECLARATION OF CONFORMITY	27

PRELIMINARY EXAMINATION

Remove the instrument from the packing material and examine it carefully to make sure that no damage has occurred during shipment. If noticeable damage is found, notify your Dealer or the nearest Hanna Customer Service Center.

Note: Save all packing material until you are sure that the instrument functions correctly. Any defective item must be returned in the original packing together with the supplied accessories.

GENERAL DESCRIPTION

HI 8014, HI 8915 and HI 931000 are hand-held pH/mV meters with interchangeable plastic-body electrodes, simple controls on the front panel, low battery detector, large easy-to-read display, simple calibration procedure and lightweight ABS plastic housing.

- **HI 8014** is an affordable portable pH/mV meter. The pH or mV ranges are easily selected with a rotary knob, as well as the °C range for manual temperature compensation. **HI 8014** comes supplied with: **HI 1230B** combination, double-junction, gel pH electrode, one 9V battery and calibration screwdriver.
- **HI 8915** is a portable pH/mV/°C meter that combines accurate pH measurements with a recorder output capability and automatic temperature compensation. Two recorder output terminals make it possible to attach a plotter or recorder directly to the meter for a hard copy of the measurements. Pressing the HOLD key will freeze the reading on the display. Calibration is performed using the two trimmers on the front panel. **HI 8915** comes supplied with: **HI 1230B** combination, double-junction, gel pH electrode, **HI 7669AW** temperature probe, one 9V battery and calibration screwdriver.
- **HI 931000** is a compact, microprocessor-based pH/°C meter, which comes supplied with: **HI 1217D** combination gel pH/°C electrode with built-in temperature sensor and signal amplifier, one 9V battery and **HI 710004** soft carrying case.

FUNCTIONAL DESCRIPTION HI8014

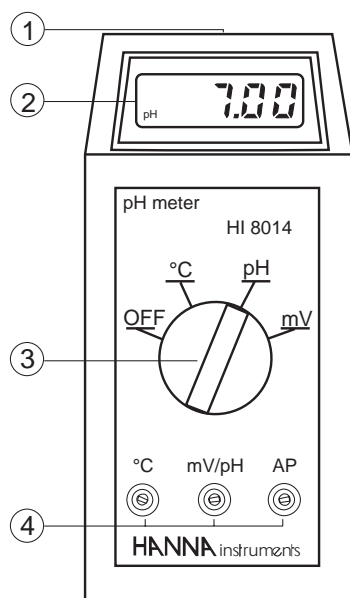

- 1) BNC socket for combination pH electrodes.
- 2) Liquid Crystal Display (LCD).
- 3) **Rotary Knob** with the following selectable positions:
 - OFF** To switch the meter off (in any other position the instrument is on).
 - °C** To display the manual temperature setting (through °C trimmer).
 - pH** To display the pH value.
 - mV** To display the mV (ORP) readings when using an ORP electrode or the mV equivalent to the pH values when using a pH electrode.
- 4) **Trimmers:**
 - °C** To set temperature manually.
 - mV/pH** For SLOPE calibration of pH.
 - AP** For OFFSET calibration of pH.

SPECIFICATIONS HI8014

		HI 8014
Range	pH	0.00 to 14.00
	mV	±1999
Resolution	pH	0.01
	mV	1
Accuracy (@20°C/68°F)	pH	±0.01
	mV	±1
Typical EMC Deviation	pH	±0.05
	mV	±8
pH Calibration	Manual 2 point through offset and slope trimmers	
Offset Calibration	±1 pH	
Slope Calibration	from 85 to 105%	
Temperature Compensation	Manual from 0 to 100°C (32 to 212°F)	
pH Electrode	HI 1230B combination, double-junction, gel-filled, with BNC connector and 1 m (3.3') cable (included)	
Input Impedance	10 ¹² ohm	
Battery Type	1 x 9V	
Life	100 hours of continuous use	
Environment	0 to 50°C (32 to 122°F); max 95% RH non-condensing	
Dimensions	185 x 82 x 53 mm (7.3 x 3.2 x 2.1")	
Weight	265 g (9.3 oz.)	

FUNCTIONAL DESCRIPTION HI8915

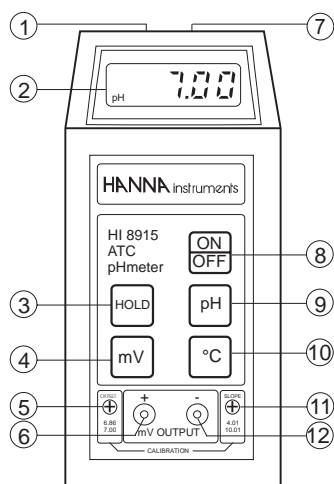

- 1) BNC socket for combination pH or ORP electrodes.
- 2) Liquid Crystal Display (LCD).
- 3) **HOLD** key, to freeze the reading on the display.
- 4) **mV** key, to display the mV (ORP) readings when using an ORP electrode; or the mV equivalent to the pH values when using a pH electrode.
- 5) **OFFSET** trimmer for OFFSET calibration of pH
- 6) + recorder output (mV output, positive connection).
- 7) Phono plug socket for **HI7669AW** temperature probe.
- 8) **ON/OFF** key, to switch the instrument on or off.
- 9) **pH** key, to display the pH value.
- 10) **°C** key, to display the temperature measurement (when the temperature probe is disconnected, the LCD will show 25°C).
- 11) **SLOPE** trimmer for SLOPE calibration of pH.
- 12) - recorder output (mV output, negative connection).

SPECIFICATIONS HI8915

		HI 8915
Range	pH	0.00 to 14.00
	mV	±1999
	°C	0.0 to 100.0
Resolution	pH	0.01
	mV	1
	°C	0.1
Accuracy (@20°C/68°F)	pH	±0.01
	mV	±1
	°C	±0.5
Typical EMC Deviation	pH	±0.02
	mV	±1
	°C	±0.8
pH Calibration		Manual 2 point through offset and slope trimmers
Offset Calibration		±1 pH
Slope Calibration		from 85 to 105%
Temperature Compensation		Automatic from 0 to 70°C (32 to 158°F) or fixed at 25°C (77°F) with temperature probe detached
pH Electrode		HI 1230B combination, double-junction, gel-filled with BNC connector and 1 m (3.3') cable (included)
Temperature Probe		HI 7669AW (included)
Input Impedance		10 ¹² ohm
Recorder Output		100 mV/pH 1mV/mV 10mV/°C
Battery Type Life		1 x 9V 100 hours of continuous use
Environment		0 to 50°C (32 to 122°F); max 95% RH non-condensing
Dimensions		185 x 82 x 53 mm (7.3 x 3.2 x 2.1")
Weight		265 g (9.3 oz.)

FUNCTIONAL DESCRIPTION HI931000

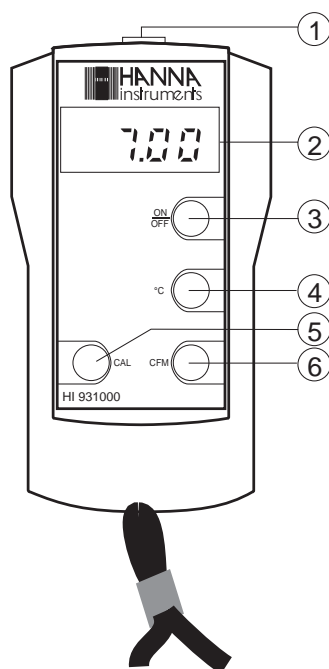

- 1) DIN socket for combination pH/°C electrode.
- 2) Liquid Crystal Display (LCD).
- 3) **ON/OFF** key, to switch the instrument on or off.
- 4) **°C** key, to display the measured temperature (press & hold).
- 5) **CAL** key, to enter calibration mode.
- 6) **CFM** key, to confirm calibration data.

SPECIFICATIONS HI931000

		HI 931000
Range	pH	0.00 to 14.00
	°C	0.0 to 70.0
Resolution	pH	0.01
	°C	0.1
Accuracy (@20°C/68°F)	pH	±0.01
	°C	±0.5
Typical EMC Deviation	pH	±0.30
	°C	±1
pH Calibration	Automatic 2 point with 3 memorized standard buffers (pH 7.01, 4.01, 10.01)	
Temperature Compensation	Automatic from 0 to 70°C (32 to 158°F)	
pH Electrode	HI 1217D combination, gel with built-in temperature sensor and amplifier (included)	
Battery Type	1 x 9V	
Life	300 hours of continuous use Auto-off after 8 minutes of non-use	
Environment	0 to 50°C (32 to 122°F); max 95% RH non-condensing	
Dimensions	143 x 80 x 38 mm (5.6 x 3.2 x 1.5")	
Weight	360 g (12.7 oz.)	

OPERATIONAL GUIDE

INITIAL PREPARATION

Each meter is supplied complete with a 9V battery. Slide off the battery compartment cover on the back of the meter, install the battery while paying attention to its polarity.

Always remove the electrode protective cap before taking any measurements. If the electrode has been left dry, soak the tip (bottom 4 cm / 1½") in pH7 or pH4 buffer solution for a few hours or overnight to reactivate it.

For HI 8014:

Connect the pH electrode to the BNC socket on the top of the meter. Switch the meter on by turning the rotary knob to the °C, pH or mV position.

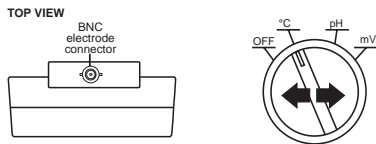

For HI 8915:

Connect the pH electrode to the BNC socket on the top of the instrument. Connect the temperature probe to the other socket. The temperature probe can be used independently to take temperature measurements, or it can be used in conjunction with the pH electrode to utilize the meter's ATC capability.

Turn the meter on by pressing ON/OFF.

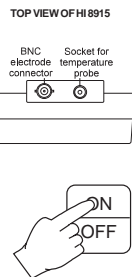

For HI 931000:

Attach the pH/°C electrode to the DIN socket on the top of the meter, tighten the retainer ring and turn the meter on by pressing ON/OFF.

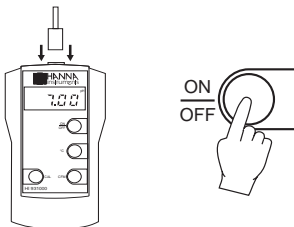

10

pH MEASUREMENTS

For HI 8014:

To take a pH measurement simply submerge the tip (4cm/1½") of the electrode and a *ChecktempC* (or another accurate thermometer) in the sample to be tested.

Turn the rotary knob to the °C position to display temperature setting on the LCD.

Using the provided screwdriver, turn the temperature trimmer to display the temperature measured by *ChecktempC*, e.g. 25°C.

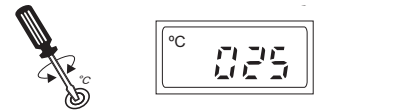

Turn the rotary knob to the pH position to display the pH measurement.

Shake the electrode briefly and allow a couple of minutes for the electrode to adjust and stabilize. The display will show the pH value compensated for the manually adjusted temperature.

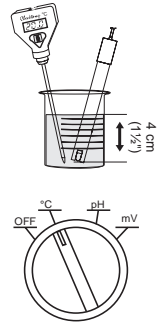

For HI 8915:

To take a pH measurement simply submerge the tip (4cm/1½") of the electrode and the temperature probe in the sample to be tested.

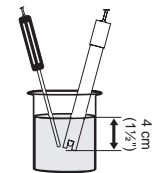

For HI 931000:

Simply submerge the tip (4cm/1½") of the combination pH/temperature electrode in the sample.

Turn the instrument ON, shake the electrode briefly and wait until the stability indicator "Δ" stops blinking. The display will show the pH value compensated for temperature.

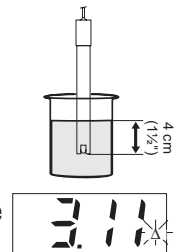

11

Notes:

- In order to take accurate pH measurements, make sure that the instrument is calibrated for pH before use.
- For a faster response time when using **refillable electrodes**, unscrew the refill hole cap.



- If measurements are taken in different samples successively, it is recommended to clean the electrode thoroughly to eliminate cross-contamination. After cleaning, rinse the electrode with some of the sample to be measured.

TEMPERATURE COMPENSATION

The pH reading is directly affected by temperature. In order for the meter to measure the pH accurately temperature must be taken into consideration.

HI 931000 uses an electrode with a built-in temperature sensor and therefore no additional temperature probe is needed.

To use the Automatic Temperature Compensation feature of **HI 8915**, submerge the temperature probe into the sample as close to the electrode as possible and wait for a couple of minutes. The displayed pH reading is compensated for the temperature variance. When the temperature probe is disconnected, the pH reading will be compensated at 25°C.

HI 8014 provides only for manual compensation.

ORP MEASUREMENTS (HI 8014 & HI 8915)

Connect an ORP electrode to the BNC socket on the top of the meter. To enter the "mV" mode (ORP Oxidation Reduction Potential) turn the instrument ON and select the mV mode.

To measure the mV of a sample submerge submerge the ORP electrode tip (4 cm/1½") in the sample to be tested.

Allow a few minutes for the readings to stabilize. Also, see further on for more information about REDOX measurements.

TEMPERATURE MEASUREMENTS (not for HI 8014)

Turn the instrument ON and press °C.

Make sure the temperature probe (for **HI 8915**) or the pH/°C electrode (for **HI 931000**) is connected to the meter.

Dip the temperature probe or the pH/°C electrode into the sample and allow the reading to stabilize (a couple of minutes).

For **HI 931000**, to display the measured temperature, press and hold the °C key. When the key is released, the display will return to the pH reading.



HOLD FUNCTION (HI 8915 only)

The hold function is activated by the HOLD key. The measured value is frozen on the display when this key is pressed. "S" symbol will appear on the display to indicate the holding (storage) mode.

Press the HOLD key again to return to the normal mode.

AFTER MEASUREMENTS

After measurements switch the instrument off to save the battery, disconnect the electrode from the meter and store it with a few drops of **HI 70300** storage solution in the protective cap.

pH CALIBRATION

For best accuracy, frequent calibration of the instrument is recommended. The instrument should be recalibrated for pH:

- Whenever the pH electrode or temperature probe is replaced.
- At least once a month.
- After testing aggressive chemicals.
- Whenever the battery has been replaced.
- When high accuracy is required.

PREPARATION

Pour small quantities of pH 7.01 (HI 7007) and pH 4.01 (HI 7004) solutions into two clean beakers.

For accurate calibration use two beakers for each buffer solution: the first one for rinsing the tip of the electrode, the second one for calibration. This way, contamination of the buffers is minimized.

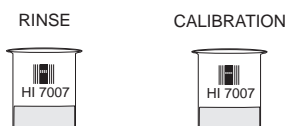

For accurate readings, use pH 7.01 (HI 7007) and pH 4.01 (HI 7004) if you are going to measure acidic samples, or pH 7.01 (HI 7007) and pH 10.01 (HI 7010) for alkaline measurements.

If you need to calibrate HI 8014 and HI 8915 to NBS standards, use pH 6.86 (HI 7006) instead of pH 7.01 and pH 9.18 (HI 7009) instead of pH 10.01.

PROCEDURE FOR HI 8014

- Remove the protective cap from the electrode, rinse and immerse it in pH 7.01 buffer and stir gently. Wait a couple of minutes for the reading to stabilize.
- Take the temperature of the buffer solution with a *ChecktempC* (or another accurate thermometer), e.g. 20°C.



Note: The electrode should be submerged approximately 4 cm (1½") into the solution. The *ChecktempC* should be located as close as possible to the pH electrode.

- Set the rotary knob to °C position to display the manual temperature setting and adjust the °C trimmer until the LCD shows the measured temperature.



- Set the rotary knob to pH position to display pH measurement and wait for the reading to stabilize and adjust the AP trimmer with a small screwdriver until the LCD shows the pH value at the above temperature (see page 18 for pH vs. temperature chart).

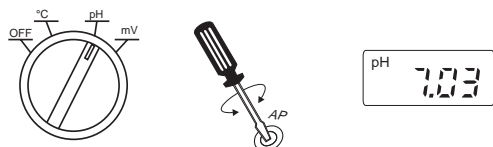

- Rinse and immerse pH electrode and thermometer in pH 4.01 or pH 10.01 buffer (2nd calibration point); stir gently.



- Wait a couple of minutes, then adjust the mV/pH trimmer until the LCD shows the pH value at the noted temperature (see page 18 for pH vs. temperature chart).

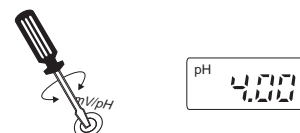

The pH calibration is now complete.

PROCEDURE FOR HI 8915

- First connect the pH electrode and the temperature probe to the instrument, then switch it ON.
- Remove the electrode protective cap, rinse the electrode tip with some pH 7.01 solution, then immerse the pH electrode and temperature probe in a pH 7.01 buffer solution.



- Stir gently and wait a couple of minutes for thermal equilibrium.

Note: The electrode should be submerged approximately 4 cm (1½") into the solution. The temperature probe should be located as close as possible to the pH electrode.

- Press °C to display the temperature of the buffer (e.g. 20.0°C).

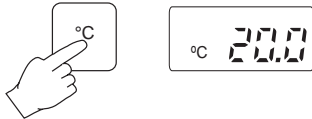

- Press the pH key to read pH values. Stir gently and wait for a couple of minutes.



- Adjust the OFFSET trimmer on the front panel until LCD shows the pH value at the noted temperature (see the pH vs. temperature chart on page 18).

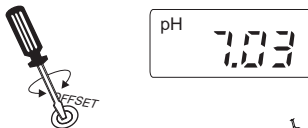

- Rinse and immerse pH electrode and temperature probe in pH 4.01 or pH 10.01 buffer (2nd calibration point); stir gently.



- Wait a couple of minutes and adjust the SLOPE trimmer on the front panel until the LCD shows the pH value at the noted temperature.

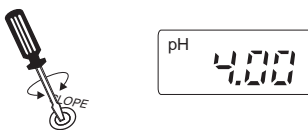

The pH calibration is now complete.

PROCEDURE FOR HI 931000

- Turn the meter on.

Note: The "Δ" indicator blinks when the reading is not stable.

- Press CAL and the display will flash "7.01 Δ".

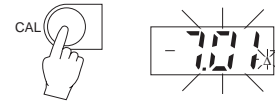

- Remove the electrode protective cap, rinse the electrode tip with some pH 7.01 solution, then immerse the pH electrode and temperature probe in a pH 7.01 buffer solution.

- Stir gently and wait a couple of minutes for thermal equilibrium.

Note: The electrode should be submerged approximately 4 cm (1½") in the solution.

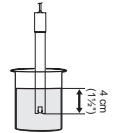

- When electrode has stabilized, the "Δ" indicator stops flashing. Press CFM to confirm the first buffer solution.

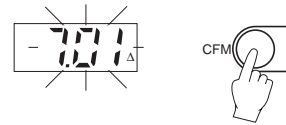

- To quit the calibration mode and save a one-point (offset) procedure, press the ON/OFF key. For best accuracy, however, it is recommended to perform a two-point calibration.

- The LCD will now blink "4.01 Δ". pH 10.01 can be selected by pressing the CAL key.



- Rinse the electrode with the second buffer solution (pH 4.01 or pH 10.01).

- Dip the electrode into the buffer solution, stir gently and wait until the instability indicator "Δ" stops flashing. Press CFM to confirm the second buffer solution.

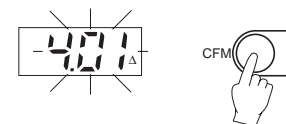

The meter is now calibrated and will return to operational mode.

pH VALUES AT VARIOUS TEMPERATURES

For manual temperature compensation during calibration, please refer to the following chart.

TEMP		pHVALUES				
°C	°F	4.01	6.86	7.01	9.18	10.01
0	32	4.01	6.98	7.13	9.46	10.32
5	41	4.00	6.95	7.10	9.39	10.24
10	50	4.00	6.92	7.07	9.33	10.18
15	59	4.00	6.90	7.04	9.27	10.12
20	68	4.00	6.88	7.03	9.22	10.06
25	77	4.01	6.86	7.01	9.18	10.01
30	86	4.02	6.85	7.00	9.14	9.96
35	95	4.03	6.84	6.99	9.10	9.92
40	104	4.04	6.84	6.98	9.07	9.88
45	113	4.05	6.83	6.98	9.04	9.85
50	122	4.06	6.83	6.98	9.01	9.82
55	131	4.07	6.84	6.98	8.99	9.79
60	140	4.09	6.84	6.98	8.97	9.77
65	149	4.11	6.85	6.99	8.95	9.76
70	158	4.12	6.85	6.99	8.93	9.75

For instance, if the buffer temperature is 25°C, the display should show pH 4.01 or 7.01 or 10.01. With the temperature at 20°C, the display should show pH 4.00 or 7.03 or 10.06. Likewise, at 50°C, the display should show pH 4.06 or 6.98 or 9.82.

TAKING REDOX MEASUREMENTS

HI 8014 and HI 8915 have the capability to take ORP measurements, if using an optional ORP electrode.

Oxidation-reduction potential (REDOX) measurements provide the quantification of the oxidizing or reducing power of the sample tested. To correctly perform a redox measurement, the surface of the ORP electrode must be clean and smooth.

When not in use, the tip of the electrode should be kept moist and safe from any mechanical stress which might cause damage to the glass-platinum junction.

TEMPERATURE CALIBRATION

HI 8915 and HI 931000 have been accurately precalibrated for temperature at the factory.

For optimum accuracy, it is recommended that you have your pH meter recalibrated for temperature at least once a year.

Contact your Dealer or the nearest Hanna Customer Service Center for more information.

mV OUTPUT

It is possible to attach the HI 8915 to a recorder or plotter using the mV output sockets.

pH, mV and °C readings can be transmitted through the output sockets at a voltage that proportionally matches the displayed value. For example, when the meter reads 2.00, 7.00 or 12.00 pH, it emits a 200, 700 or 1200 mV signal, respectively.

This makes it unnecessary to use conversion tables and charts.

The output signals for the three measurement ranges of the meter are 100 mV for every pH unit, 1mV for every mV unit and 10 mV for every degree centigrade.

DISPLAY CODES GUIDE

HI 8014 and HI 8915

°C Symbol indicates the meter is in temperature mode.

pH Symbol indicates the meter is in pH mode.

mV Symbol indicates the meter is in mV mode.

HI 8915

S Symbol to indicate the display is frozen (Hold function).

HI 931000

Δ Stability indicator

Ec Wrong buffer: Change the buffer solution;
Unfit electrode: Clean and condition the electrode.

Eb Low battery: Replace the battery.

Er Over-Range: Dry electrode, repeat conditioning.

ELECTRODE CONDITIONING AND MAINTENANCE

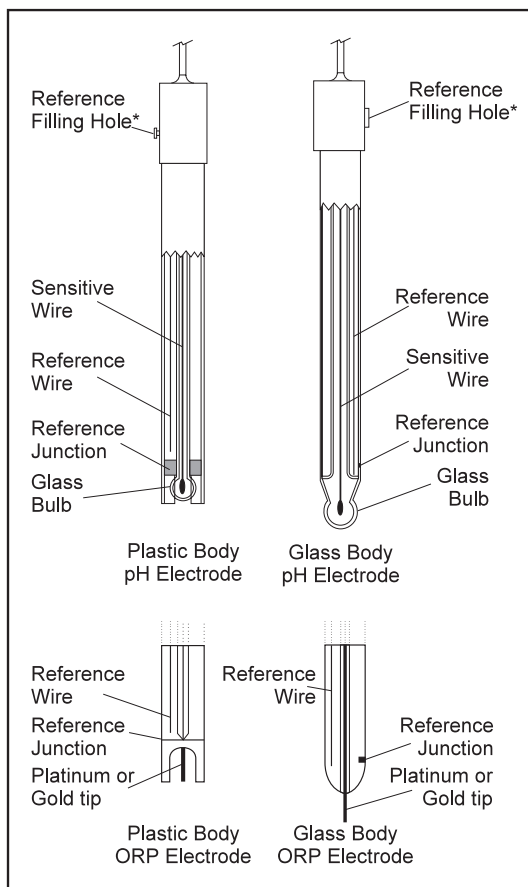

* Only available with refillable electrodes.

PREPARATION

Remove the protective cap.

DO NOT BE ALARMED IF ANY SALT DEPOSITS ARE PRESENT. This is normal with electrodes and they will disappear when rinsed with water.

During transport tiny bubbles of air may have formed inside the glass bulb. The electrode cannot function properly under these conditions. These bubbles can be removed by "shaking down" the electrode as you would do with a glass thermometer.

If the bulb and/or junction are dry, soak the electrode in **HI 70300 Storage Solution** for at least one hour.

For refillable electrodes:

If the refill solution (electrolyte) is more than 2½ cm (1") below the fill hole, add **HI 7082** (3.5M KCl Electrolyte Solution) for double junction or **HI 7071** (3.5M KCl+AgCl Electrolyte Solution) for single junction electrodes.

TEST MEASUREMENT

Rinse the electrode tip with distilled water. Immerse the tip (bottom 4 cm / 1½") in the sample and stir gently for approx. 30 seconds. For a faster response and to avoid cross contamination of the samples, rinse the electrode tip with the solution to be tested, before taking any measurements.

STORAGE

To minimize clogging and assure a quick response time, the glass bulb and the junction should be kept moist at any time and not allowed to dry out.

When not in use, replace the solution in the protective cap with a few drops of **HI 70300 Storage Solution**.

Follow the Preparation Procedure above before taking measurements.

NEVER STORE THE ELECTRODE IN DISTILLED OR DEIONIZED WATER.

PERIODIC MAINTENANCE

Inspect the electrode and the cable. The cable used for the connection to the meter must be intact and there must be no points of broken insulation on the cable or cracks on the electrode stem or bulb.

Connectors must be perfectly clean and dry. If any scratches or cracks are present, replace the electrode. Rinse off any salt deposits with water.

For refillable electrodes:

Refill the electrode with fresh electrolyte (**HI 7071** for single junction or **HI 7082** for double junction electrodes). Allow the electrode to stand upright for 1 hour. Follow the Storage Procedure above.

CLEANING PROCEDURE

General Soak in Hanna **HI7061** General Cleaning Solution for approximately 30 minutes.

Removal of films, dirt or deposits on the membrane/junction:

Protein Soak in Hanna **HI7073** Protein Cleaning Solution for 15 minutes.

<i>Inorganic</i>	Soak in Hanna HI 7074 Inorganic Cleaning Solution for 15 minutes.
<i>Oil/grease</i>	Rinse with Hanna HI 7077 Oil and Fat Cleaning Solution.

IMPORTANT: After performing any of the above cleaning procedures rinse the electrode thoroughly with distilled water, drain and refill the reference chamber with fresh electrolyte (not necessary for gel-filled electrodes), and soak the electrode in **HI70300** Storage Solution for at least 1 hour before taking any measurement.

TROUBLESHOOTING

Evaluate the electrode performance based on the following.

- **Noise** (Readings fluctuate up and down) could be due to:
 - **Clogged/Dirty Junction:** Refer to above Cleaning Procedure.
 - **Loss of shielding** due to low electrolyte level (in refillable electrodes only): refill with **HI 7071** for single junction or **HI 7082** for double junction electrodes.
- **Dry Membrane/Junction:** Soak in Storage Solution **HI70300** for at least 1 hour.
- **Drifting:** Soak the electrode tip in warm Hanna Solution **HI7082** for one hour and rinse tip with distilled water (refill with fresh **HI7071** for single junction electrodes and **HI7082** for double junction electrodes if necessary).
- **Low Slope:** Refer to the cleaning procedure above.
- **No Slope:**
 - Check the electrode for cracks in glass stem or bulb (replace the electrode if cracks are found).
 - Make sure cable and connections are not damaged nor lying in a pool of water or solution.
- **Slow Response/Excessive Drift:** Soak the tip in Hanna Solution **HI7061** for 30 minutes, rinse thoroughly in distilled water and then follow the Cleaning Procedure above.
- **For ORP Electrodes:** polish the metal tip with a lightly abrasive paper (paying attention not to scratch the surface) and wash thoroughly with water.

Note: For field applications, it is always recommended to keep a spare electrode handy. When anomalies are not resolved with a simple maintenance, change the electrode (and recalibrate the meter) to see if the problem is alleviated.

BATTERY REPLACEMENT

All meters are powered by a 9V battery that is located on the rear of the instrument.

The meters provide the following, when the battery becomes weak:

- **HI 8014**, reaching a certain minimum threshold, automatically switches the LCD off.
- **HI 8915** flashes an additional decimal point on the bottom left hand side of the LCD.
- **HI 931000** displays the "Eb" message.

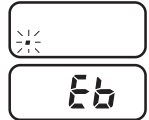

When the low battery indicator appears only a few hours of battery life is remaining. Since a low voltage may also result in loss of calibration data or unreliable measurements, it is recommended to replace the battery immediately.

Replacement must only take place in a non-hazardous area using an alkaline 9V battery.

To access the battery, remove the battery cover by applying pressure in the direction indicated below. Replace the old battery with a new one, while paying attention to its polarity.

HI 8014 - HI 8915

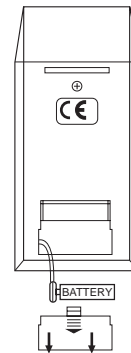

HI 931000

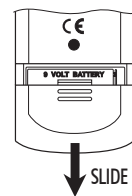

Note: The instrument should be recalibrated after changing the battery.

ACCESSORIES

pH CALIBRATION SOLUTIONS

HI 70004P	pH 4.01 buffer solution, 20 mL sachet, 25 pcs
HI 7004M	pH 4.01 buffer solution, 230 mL bottle
HI 7004L	pH 4.01 buffer solution, 500 mL bottle
HI 7006M	pH 6.86 buffer solution, 230 mL bottle
HI 7006L	pH 6.86 buffer solution, 500 mL bottle
HI 70007P	pH 7.01 buffer solution, 20 mL sachet, 25 pcs
HI 7007M	pH 7.01 buffer solution, 230 mL bottle
HI 7007L	pH 7.01 buffer solution, 500 mL bottle
HI 7009M	pH 9.18 buffer solution, 230 mL bottle
HI 7009L	pH 9.18 buffer solution, 500 mL bottle
HI 70010P	pH 10.01 buffer solution, 20 mL sachet, 25 pcs
HI 7010M	pH 10.01 buffer solution, 230 mL bottle
HI 7010L	pH 10.01 buffer solution, 500 mL bottle

ELECTRODE STORAGE SOLUTIONS

HI 70300M	Storage solution, 230 mL bottle
HI 70300L	Storage solution, 500 mL bottle

ELECTRODE CLEANING SOLUTIONS

HI 70000P	Electrode rinsing solution, 20 mL sachet, 25 pcs
HI 7061M	General cleaning solution, 230 mL bottle
HI 7061L	General cleaning solution, 500 mL bottle
HI 7073M	Protein cleaning solution, 230 mL bottle
HI 7073L	Protein cleaning solution, 500 mL bottle
HI 7074M	Inorganic cleaning solution, 230 mL bottle
HI 7074L	Inorganic cleaning solution, 500 mL bottle
HI 7077M	Oil & Fat cleaning solution, 230 mL bottle
HI 7077L	Oil & Fat cleaning solution, 500 mL bottle

REFILLING ELECTROLYTE SOLUTIONS

HI 7071	3.5M KCl + AgCl electrolyte, 4 x 50 mL, for single junction electrodes
HI 7072	1M KNO ₃ electrolyte, 4 x 50 mL
HI 7082	3.5M KCl electrolyte, 4 x 50 mL, for double junction electrodes

ORP SOLUTIONS

HI 7020M	Test solution, 200-275 mV, 230 mL bottle
HI 7020L	Test solution, 200-275 mV, 500 mL bottle
HI 7091M	Reducing pretreatment solution, 230 mL bottle
HI 7091L	Reducing pretreatment solution, 500 mL bottle
HI 7092M	Oxidizing pretreatment solution, 230 mL bottle
HI 7092L	Oxidizing pretreatment solution, 500 mL bottle

pH ELECTRODES

B = BNC CONNECTION PLUG + 1 m (3.3') CABLE

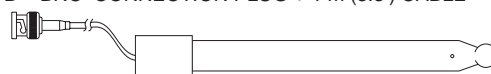

S = SCREW-TYPE CONNECTOR

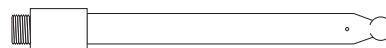

HI1043B / HI1040S	Glass body, double junction, refillable, combination pH electrode. Use: strong acid/alkali.
HI1053B / HI1050S	Glass body, triple ceramic, conic shape, refillable, combination pH electrode. Use: emulsions.
HI1083B	Glass body, micro, Viscolene, non-refillable, combination pH electrode. Use: biotechnology, micro titration.
HI1131B / HI1111S	Glass body, single junction, refillable, combination pH electrode. Use: general purpose.
HI1330B / HI1310S	Glass body, semimicro, single junction, refillable, combination pH electrode. Use: laboratory.
HI1331B / HI1311S	Glass body, semimicro, single junction, refillable, combination pH electrode. Use: flasks.
HI1230B / HI1210S	Plastic body, double junction, gel-filled, combination pH electrode. Use: general purpose.
HI2031B / HI2020S	Glass body, semimicro, conic, refillable, combination pH electrode. Use: semisolid products.
HI1332B / HI1312S	Plastic body, double junction, refillable, combination pH electrode. Use: general purpose.
FC100B	PVDF body, double junction, refillable, combination pH electrode. Use: food industry, general.
FC200B / FC200S	PVDF body, single junction, conic, Viscolene, non-refillable, combination pH electrode. Use: meat & cheese.

- FC210B** Glass body, double junction, conic, Viscolene, non-refillable combination pH electrode. Use: milk, yogurt.
- FC220B** Glass body, triple ceramic, single junction, refillable, combination pH electrode. Use: food processing.
- FC911B** PVDF body, double junction, refillable with built-in amplifier, combination pH electrode. Use: very high humidity.
- HI1413B** Glass body, single junction, flat tip, Viscolene, non-refillable combination pH electrode. Use: surface.

ORP ELECTRODES

- HI3131B / HI3111S** Glass body, refillable, combination platinum ORP electrode. Use: titration.
- HI3230B / HI3210S** Plastic body, gel-filled, combination platinum ORP electrode. Use: general purpose.
- HI4430B / HI4410S** Plastic body, gel-filled, combination gold ORP electrode. Use: general purpose.

EXTENSION CABLES (SCREW TO BNC CONNECTOR)

- HI 7855/1** Extension cable 1 m (3.3') long
- HI 7855/3** Extension cable 3 m (9.9') long

OTHER ACCESSORIES

- ChecktempC** Pocket-size thermometer (range -50.0 to 150.0°C)
- HI 710001** Soft carrying case for **HI 8014** and **HI 8915**
- HI 710004** Soft carrying case for **HI 931000**
- HI 710007** Shockproof, blue rubber boot for **HI 931000**
- HI 710008** Shockproof, orange rubber boot for **HI 931000**
- HI 710009** Shockproof, blue rubber boot (for **HI8014** and **HI8915**)
- HI 710010** Shockproof, orange rubber boot (for **HI8014** and **HI8915**)
- HI 710031** General-purpose rugged carrying case
- HI 721311** Rugged carrying case for **HI 8014** and **HI 8915** with pH 4.01 and pH 7.01 solutions and screwdriver
- HI 731326** Calibration screwdriver (20 pcs.)
- HI 7669AW** Temperature probe with 1 m (3.3') cable, for **HI 8915**
- HI 8427** pH and ORP electrode simulator with 1 m (3.3') coaxial cable ending in female BNC connectors
- HI 931001** pH and ORP electrode simulator with LCD and 1 m (3.3') coaxial cable ending in female BNC connectors

CE DECLARATION OF CONFORMITY





DECLARATION OF CONFORMITY

We

Hanna Instruments Italia Srl
 via E.Fermi, 10
 35030 Sarmeola di Rubano - PD
 ITALY

herewith certify that the pH meters

HI 8014 • HI 8915 • HI 931000

have been tested and found to be in compliance with EMC Directive 89/336/EEC and Low Voltage Directive 73/23/EEC according to the following applicable normatives:

EN 50082-1: Electromagnetic Compatibility - Generic Immunity Standard
IEC 801-2 Electrostatic Discharge
IEC 801-3 RF Radiated

EN 50081-1: Electromagnetic Compatibility - Generic Emission Standard
EN 55022 Radiated, Class B

EN61010-1: Safety requirements for electrical equipment for measurement, control and laboratory use

Date of Issue: 2-10-1998

 P. Cesa - Technical Director
 On behalf of
 Hanna Instruments S.r.l.

Recommendations for Users

Before using these products, make sure that they are entirely suitable for the environment in which they are used. Operation of these instruments in residential areas could cause unacceptable interferences to radio and TV equipment.

The glass bulb at the end of the electrode is sensitive to electrostatic discharges. Avoid touching this glass bulb at all times. During operation, ESD wrist straps should be worn to avoid possible damage to the electrode by electrostatic discharges.

Any variation introduced by the user to the supplied equipment may degrade the instrument's EMC performance. To avoid electrical shock, do not use these instruments when voltages at the measurement surface exceed 24 Vac or 60 Vdc.

In particular cases HI 8915 could change its operating mode. In such cases, press any key to return to normal operating conditions.

To avoid damages or burns, do not perform any measurement in microwave ovens.

SALES AND TECHNICAL SERVICE CONTACTS

Australia:

Tel. (03) 9769.0666 • Fax (03) 9769.0699

China:

Tel. (10) 88570068 • Fax (10) 88570060

Egypt:

Tel. & Fax (02) 2758.683

Germany:

Tel. (07851) 9129-0 • Fax (07851) 9129-99

Greece:

Tel. (210) 823.5192 • Fax (210) 884.0210

Indonesia:

Tel. (21) 4584.2941 • Fax (21) 4584.2942

Japan:

Tel. (03) 3258.9565 • Fax (03) 3258.9567

Korea:

Tel. (02) 2278.5147 • Fax (02) 2264.1729

Malaysia:

Tel. (603) 5638.9940 • Fax (603) 5638.9829

Singapore:

Tel. 6296.7118 • Fax 6291.6906

South Africa:

Tel. (011) 615.6076 • Fax (011) 615.8582

Taiwan:

Tel. 886.2.2739.3014 • Fax 886.2.2739.2983

Thailand:

Tel. 66.2619.0708 • Fax 66.2619.0061

United Kingdom:

Tel. (01525) 850.855 • Fax (01525) 853.668

USA:

Tel. (401) 765.7500 • Fax (401) 765.7575

MANPHR4 07/05

For e-mail contacts and complete list of Sales and Technical offices, please see www.hannainst.com