

# User's Guide

# **EXTECH**<sup>®</sup>

INSTRUMENTS

A FLIR COMPANY

## Video Borescope

### Models BR200 and BR250

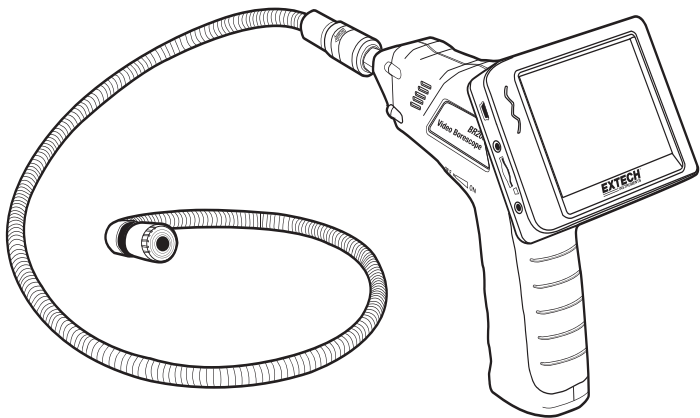

# ***Introduction***

---

Congratulations on your purchase of this Extech BR200 (17mm camera head) or BR250 (9mm camera head) Video Borescope. This instrument was designed for use as a remote inspection device. It can be used to peer into tight spots and then supply real-time video and images that can be recorded. Typical applications include HVAC inspection, automotive inspection, cable routing, and automotive/boat/aircraft inspection. This meter is shipped fully tested and, with proper use, will provide years of reliable service.

## **Features**

- 3.5 " TFT-LCD palm LCD monitor with high resolution
- The image head and the cable are water resistant when the unit is fully assembled (the monitor and the camera are not water resistant)
- Wireless and hard-wired functionality
- The monitor records video and images
- SD card capacity: 16G

## ***Safety***

---

- Do not expose instrument to moisture
- Shut off the instrument when not in use
- Remove the batteries when cleaning the instrument
- Replace all batteries at the same time

# Supplied Equipment

1. Camera
2. LCD Monitor
3. Monitor Adaptor
4. Adaptor cable
5. Accessory Magnet / Hook / Mirror
6. Magnetic mount
7. Flex cable and camera head
8. 4 AA Batteries



1



2



3



4



5



6



7



8

## Description

---

- 1 Signal output
- 2 Power Indicator
- 3 Power On/Off, Dimmer
- 4 Flexible tube
- 5 Camera head and LED's
- 6 OK
- 7 Up, video or jpg
- 8 Menu
- 9 Down. Channel select (4)
- 10 Power On/Off
- 11 Power Indicator
- 12 USB Socket
- 13 Video output
- 14 SD card socket
- 15 Power supply socket
- 16 Reset
- 17 Signal input

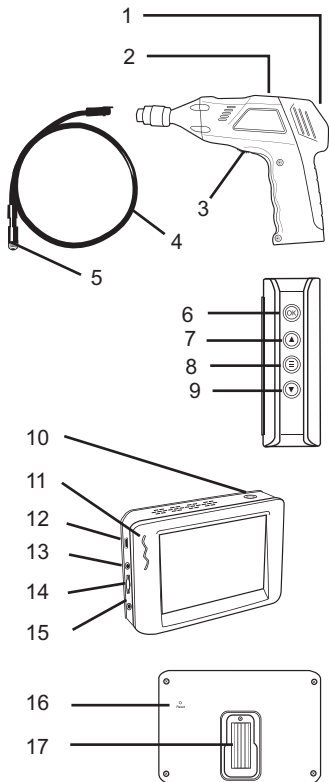

# Installation

---

Install the batteries into the instrument body, charge the monitor battery, connect the camera and flexible tube to the body, insert the micro SD card. Install any accessory as needed.

## Battery Installation

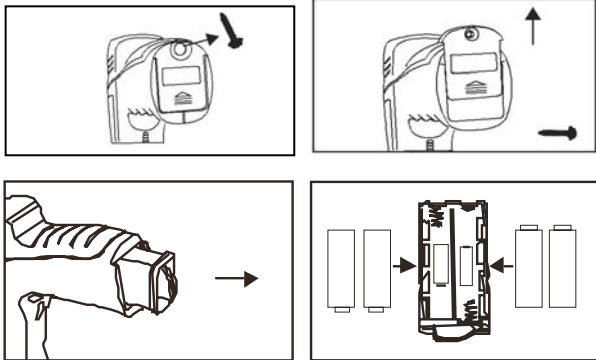

## Connect Monitor Power

The monitor has a rechargeable battery. Plug in the AC adaptor and connect the cable to the *DC5V* socket on the monitor. The power indicator will light in red (or the battery capacity icon on LCD of monitor will blink, indicating that it is charging - and will turn off after a full charge)

## Connect the camera and flexible tube

Connect the camera tube to the instrument body; ensure that the keyed ends are properly aligned. Once aligned, tighten the knurled knob to hold the connection firmly in place.

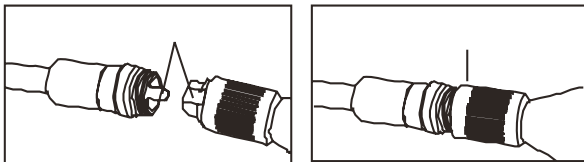

**Warning.** Permanent damage to the flex tube and loss of operation will occur if the flex tube is subjected to narrow radius or sharp angle bends.

### Inserting the micro SD card

Insert card with arrow pointing toward slot. Gently apply pressure until card locks into the spring loaded slot. To remove from unit, gently push the card inward and then release to eject it from the card slot.

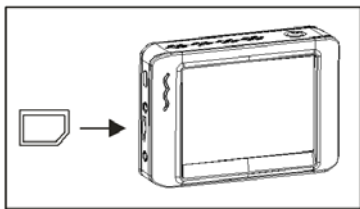

### Installing the accessory tools (BR200)

The included accessories (mirror, hook and magnet) all attach to the camera in the same manner. Refer to the diagrams below:

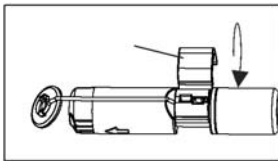
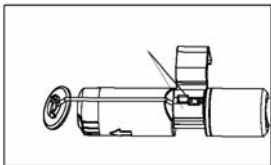

## Installing the accessory tools (BR250)

Hook the attachment into the hole in the head and then slide the rubber sleeve over the attachment shaft

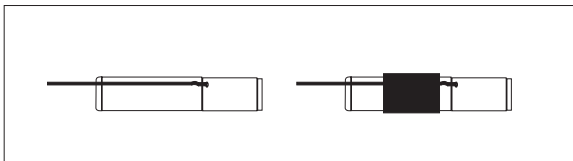

## Attaching the Monitor to the instrument body

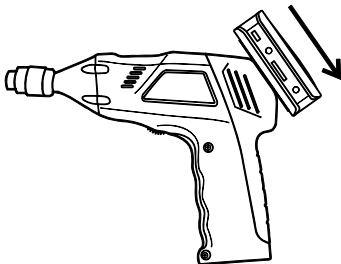

## Connect the USB Cable

Use the USB cable to connect the monitor to a PC. The USB online icon will appear on the PC. Open **My Computer** on the PC, and locate the **Mobile Disk**. The **Mobile disk** can be used and accessed in the same manner as any external hard drive.

## Video Output

Insert the video cable into the VIDEO OUT socket on the monitor. Insert the other end of the cable into the VIDEO IN jack of a TV or other monitor. The LCD Monitor will output a high quality video image.

## Installing the Magnetic bracket

The magnetic bracket slides onto the rear of the monitor for convenient placement and viewing.

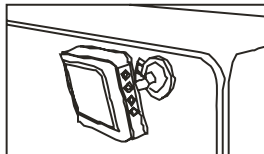
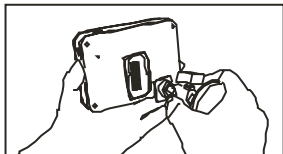





# Operation

---

## Basic Operation

1. Turn the ON/OFF dial switch to power the camera. The power indicator will switch on. The switch then acts as a dimmer for the two LEDs on the imager head of the camera.
2. Press and hold the monitor power switch for at least 2 seconds and the power indicator will illuminate green and a *Welcome* screen will appear.
3. Before attaching the monitor to the instrument body, press the down arrow button to select channel 4. The real time image will appear on the display LCD monitor.

**Note.** If the picture does not properly synchronize or has poor color, check that the Video System Settings are set to "NTSC", not to "PAL". This should fix the condition..

4. Use the up arrow to select video  or photo  mode.
5. Turn the ON/OFF dial to adjust the LED light intensity as desired.
6. The tube can be easily maneuvered into position. The tube can be bent into the shape of the area to be examined.
7. Use the supplied accessories to help retrieve small items.

## Taking a Picture

In Photo  mode, press OK to take a picture. The photo will automatically save to the SD card.



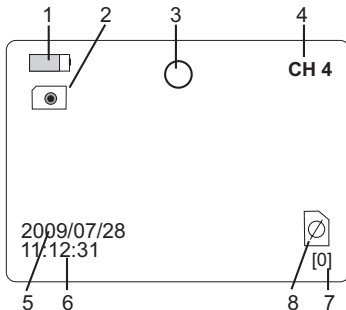

## Recording a Video

In Real-Time Monitoring (video) mode, press OK to begin recording; refer to the following diagram for display icon definitions:

1. Battery capacity
2. Function icon (video/photo)
3. Recording in progress
4. Channel
5. Date
6. Time Stamp
7. REC Time remaining
8. SD card



### Viewing a Photo or Video

1. In the Real-Time Monitoring mode, press  to display a list of dated playback folders
2. Use the   keys to select the desired folder.
3. Press OK to open the selected folder and view a list of photo or video files.
4. Files are listed by time followed by (**VID**"") for photos or (**VID**) for videos
5. Use the   keys to select a file.
6. Press OK to display the selected photo or video.

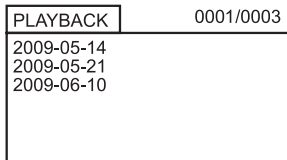



For video files:



Press OK to pause while playing.

Press again to resume.

 Fast Forwards the video

 Rewinds the video

Press  to stop video

7. Press  to return to menu.
8. Press  again to exit.

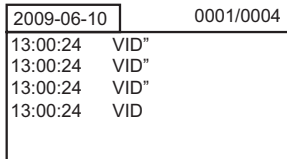



**Note:** Video automatically saves to file every 30 minutes. When the SD card is filled to capacity, the SD card icon changes to 'F'. No video will be recorded if the SD card is not inserted in the slot.

## Delete a Single Video Or Photo

1. In the Real-Time Monitoring mode, press  to display a list of dated playback folders
2. Use the **▼▲** keys to select the desired folder.
3. Press OK to open the selected folder and view a list of photo or video files.

PLAYBACK	0001/0003
2009-05-14	
2009-05-21	
2009-06-10	

4. Files are listed by time followed by (**VID"**) for photos or (**VID**) for videos
5. Use the **▼▲** keys to select a file.
6. Press and HOLD the  button, the display will show '**DELETE CURRENT FILE?**'
7. Use the arrow keys to select **YES** or **NO**
8. Press OK to accept selection.
9. Press  twice to exit the Delete screen.

2009-06-10	0001/0004
13:00:24	VID"
13:00:24	VID"
13:00:24	VID"
13:00:24	VID

## Delete a File Folder

To delete a folder, use the same instructions for deleting a single video or photo. The only additional concern is that if a folder is not empty it cannot be deleted. Delete all of the files in a folder before deleting the folder. If the user attempts to delete a folder that is not empty, the following message will appear: FOLDER NOT EMPTY

## Video Display on a PC

Several methods are available to playback or to copy video files on a PC. When connected, the files will become available as new drives on the PC.

1. SD card adaptor: Insert the mini SD card into the SD adaptor and then insert the adaptor into the PC SD slot (if available)
2. USB adaptor: Insert the mini SD card into a USB adaptor and plug into a USB port.

3. USB cable. Connect the USB cable from the camera to the PC.

## ***Settings Mode***

---

Press and hold  for two seconds to enter the Settings Mode.

### **Language Settings**

1. In Settings Mode, use the arrow keys to select SYSTEM SETTING (green icon).
2. Press OK to call up the SYSTEM icon list
3. Use the arrow keys to highlight the Language icon (globe)
4. Press OK and the Language icon list will appear (flags)
5. Use the arrow keys to highlight the desired language
6. Press OK to select the highlighted language and exit

### **Video System Settings**

1. In Settings Mode, use the arrow keys to select SYSTEM SETTING (green icon).
2. Press OK to call up the SYSTEM icon list
3. Use the arrow keys to highlight the Video System icon (yellow)
4. Press OK and the Video format selections will appear (NTSC, PAL)
5. Use the arrow keys to highlight NTSC
6. Press OK to select the highlighted format and exit

### **Format and Erase Media**

1. In Settings Mode, use the arrow keys to select SYSTEM SETTING (green icon).
2. Press OK to call up the SYSTEM icon list
3. Use the arrow keys to highlight the FORMAT icon (blue)
4. Press OK and the FORMAT selection screen will appear (YES, NO)
5. Use the arrow keys to highlight the desired response
6. Press OK to accept the selection and exit

## **Restoring Factory Default Settings**

1. In Settings Mode, use the arrow keys to select SYSTEM SETTING (green icon).
2. Press OK to call up the SYSTEM icon list
3. Use the arrow keys to highlight the DEFAULT icon (red)
4. Press OK and the DEFAULT selection screen will appear (YES, NO)
5. Use the arrow keys to highlight the desired response
6. Press OK to accept the selection and exit

## **View Version**

1. In Settings Mode, use the arrow keys to select SYSTEM SETTING (green icon).
2. Press OK to call up the SYSTEM icon list
3. Use the arrow keys to highlight the VERSION icon (green)
4. Press OK to view the version
5. Press OK again to exit

## **Frame Rate Setting**

1. In Settings Mode, use the arrow keys to select RECORDER SETTING (red icon).
2. Press OK to call up the RECORDER options
3. Use the arrow keys to highlight the FPS (frames per second) icon
4. Press OK to open the FPS parameter
5. Use the arrows to select the frame rate: 10, 15, 20, 25, or 30
6. Press OK to confirm

## Time Stamp ON OFF Setting

1. In Settings Mode, use the arrow keys to select RECORDER SETTING (red icon).
2. Press OK to call up the RECORDER options
3. Use the arrow keys to highlight the Time Stamp icon (purple)
4. Press OK to open the parameter
5. Use the arrows to select ON or OFF
6. Press OK to confirm

## Date/Time Setting

1. In Settings Mode, use the arrow keys to select DATE-TIME SETTING (yellow icon).
2. Press OK to call up Date and Time Settings window
3. Use OK to tab through the fields
4. Use the arrow keys to change a field setting
5. Press the  button to exit

## Battery Replacement

---



You, as the end user, are legally bound (**EU Battery ordinance**) to return all used batteries, **disposal in the household garbage is prohibited!** You can hand over your used batteries / accumulators at collection points in your community or wherever batteries / accumulators are sold!

**Disposal:** Follow the valid legal stipulations in respect of the disposal of the device at the end of its lifecycle

## Troubleshooting:

---

### Power Reset for the LCD Unit

In the event of a power failure in the BR200/250 LCD display unit, follow the steps below to perform a power reset:

1. Un-dock the LCD module from the BR200/250 pistol-grip base unit.
2. Connect the AC adapter to the LCD module and the appropriate AC power source.
3. Locate the Reset port on the reverse side of the LCD module (labeled *Reset*).
4. Momentarily press the Power Reset button for at least 2 seconds and then release.
5. Leaving the AC adapter connected to the LCD module, power the unit on.
6. If the unit powers on, allow it to fully re-charge (up to 2 hours) before removing the AC adapter. If the LCD unit does not power on, repeat steps 1 through 6.

## Specifications

---

### CAMERA

Imaging Sensor	CMOS
Total Pixels (NTSC)	BR200: 712 x 486; BR250: 640 x 480
Horizontal View Angle	BR200: 50 degrees BR250: 45 degrees
Transmission Frequency	2468MHz
Focus point	BR200: 20cm (8"), BR250: 10cm (4")
Minimum Illumination	0 Lux
Modulation Type	FM
Bandwidth	18MHz
Power Supply	4 x AA batteries
Unobstructed Effective Range	10m
Waterproof Capacity	IP67 (imager head only)
Dimensions (W D H)	186 x 145 x 41(mm) (Exclude Flexible Tube)

Weight (approx)	BR200: 530g BR250: 450g
Camera head Diameter	BR200: 17mm (0.67") BR250: 9mm (0.36")
Operating Temperature	-10°C~+50°C +14°F~+122°F

## MONITOR

LCD Screen Type	3.5" TFT-LCD
Effective Pixels	320 (R.G.B.) x 240
Video System	PAL/NTSC
Transmission Frequency	2414, 2432, 2450, 2468MHz
Exterior Supply Voltage	5VDC
Consumption Current (Max.)	500mA
Charge Time	3 hours
Work Time	2 hours
Video Output Level	0.9-1.3VP-P@75Ω
Receiving Sensitivity	≤-85dBm
Dimensions (W x D x H)	100 x 70 x 25(mm)
Weight (Approx)	140g
Operating Temperature	-10°C~+50°C +14°F~+122°F
Operating Humidity (Max.)	15~85%RH

## FCC Information

This device complies with part 15 of the FCC rules.  
BR250/200: FCC-ID TW5GB8802-GB8803

Operation is subject to the following two conditions:

1. This device may not cause harmful interference
2. This device must accept any interference received, including interference that may cause undesired operation.

**Copyright © 2011 Exttech Instruments Corporation (a FLIR company)**

All rights reserved including the right of reproduction in whole or in part in any form.